



«Chromos 4» User Manual

Chromos Engineering, LLC
Dzerzhinsk, Russia

Release date: Friday 17th January, 2025
Latest software version: 4.12
Internet: kb.has.ru

Contents

1. Introduction	1
2. Terms and Conditions	2
3. Hardware Requirements	4
4. Installing the Software	5
5. «Chromos 4» Overview	6
5.1. Key Concepts	6
5.2. Program Structure	9
5.2.1. Main Program Components	9
5.2.2. Program Window	10
5.2.3. Menu System	11
5.2.4. Chromatogram Window	11
5.2.5. Control Panel	13
5.2.6. Calibration and Conventional Chromatograms	14
5.3. Options	15
5.3.1. View Tab	15
5.3.2. Warnings Tab	15
5.3.3. Automation Tab	18
5.3.4. Paths Tab	18
5.3.5. Other... Tab	20
5.3.6. Interface Tab	21
5.3.7. Sounds Tab	23
5.4. User Options	23
5.5. Operation Log	25
6. Chromos Software Operating Instructions	26
6.1. Registering the Software	26
6.2. Managing the User Parameters	27
6.3. Managing the External Tools	28
6.4. Connecting the Device	28
6.5. Launching the Instrument	30
6.6. Device Configuration	30
6.6.1. Chromatograph Configuration	30
6.6.2. Other Devices Settings	35
6.7. Configuring the Instrument	35
6.7.1. Setting the Chromatograph Parameters	35
6.7.2. Configuring Sampler Parameters	38
6.7.3. Gas Flow Regulators (GFRs)	39
6.7.4. Configuring Gas Flow Regulators (GFRs)	40
6.7.5. Inlet Pressure Control	41
6.7.6. Disabling the Inlet Pressure Control	41

6.8.	Adjusting the Instrument	42
6.9.	Creating an Analysis Method	43
6.10.	Opening a Chromatogram	45
6.11.	Recording a Chromatogram	46
6.12.	Scheduling	46
6.13.	Noise Estimating	47
6.14.	Peak Auto-Marking	48
6.14.1.	Width	48
6.14.2.	Width Doubling	49
6.14.3.	Maximum Distance Between Peaks with a Common Baseline	50
6.14.4.	Maximum Shoulder Area	51
6.14.5.	Marking Start	52
6.14.6.	Minimum Height	52
6.14.7.	Minimum Area	52
6.14.8.	Maximum Width	52
6.14.9.	Disable/Enable Peak Marking	52
6.14.10.	Merge Peaks/Stop Peak Merging	52
6.14.11.	Enable/Disable Negative Peak Marking	53
6.14.12.	Move Baseline Left/Right	53
6.14.13.	Filtering	53
6.15.	Configuring the Peak Auto-Marking	53
6.15.1.	Filtering	55
6.16.	Manual Peak Marking	55
6.16.1.	Configuring the Manual Peak Marking	56
6.17.	Selected Peak Marking	57
6.18.	Creating a Peak Group	57
6.19.	Peak Identification	58
6.19.1.	Identifying Peaks	58
6.20.	Chromatogram Passport	59
6.20.1.	Filling in a Chromatogram Passport	60
6.21.	Chromatogram Report	60
6.21.1.	Generating a Chromatogram Report	61
6.21.2.	Opening a Chromatogram Report	62
6.21.3.	Printing a Chromatogram Report	62
6.22.	Saving a Chromatogram	62
6.23.	Exporting a Chromatogram	62
6.24.	Data Exporting	63
6.25.	Data Importing	63
6.26.	Duplicating a Chromatogram	63
6.27.	Closing the Program	63
6.28.	Chromatograph Calibration	64
6.28.1.	Plotting a Calibration	64
6.28.2.	Calibration Factors Calculating	66
6.28.3.	Recording Calibration Chromatograms	68
6.28.4.	Determining an Unknown Sample	70
6.29.	Database	70
6.29.1.	Using the Database	71
6.30.	Instrument Verification	75
6.30.1.	Verifying the Instrument	77
6.31.	Statistics	77

6.31.1. Using Statistical Data	78
7. Specific Devices Operating Procedures	80
7.1. Chromos GC-1000	80
7.1.1. General	80
7.1.2. Additional	81
7.1.3. Control	82
7.1.4. Valves and Thermostats	83
7.1.5. Switching Valves	85
7.1.6. Adjustment	85
7.1.7. Errors	86
7.2. SPF-05	86
7.3. Chromos ADC-2M	86
7.4. Chromos LAS-23	88
7.5. Chromos HSS-A	90
7.6. Chromos HSS-A2	93
7.7. HT1500L Sampler	95
7.8. Chromos CD+ADC	97
7.9. Chromos Cryo	99
7.10. EChD+CD	102
8. References	105
8.1. Abbreviations and Acronyms	105
8.2. Hotkeys	106
8.3. Configuring Print Parameters	107
8.4. Chromatograph Workflow	107
8.5. Additional Recording Channels	108
8.6. Standard Method Calculations	109
8.6.1. Absolute Calibration (Classic)	110
8.6.2. Absolute Calibration (Least Squares Method)	111
8.6.3. Internal Standard (Classic)	112
8.6.4. Internal Standard (Absolute Coefficients)	113
8.6.5. Simple Normalization	115
8.6.6. Normalization with Absolute Correction Factors	115
8.6.7. Normalization with Relative Correction Factors	116
8.6.8. External Standard	116
8.6.9. Internal Standard Model	116
8.7. Calculating the Split Ratio	117
8.8. Gas Flow Regulator Operating Modes	117
8.8.1. Constant Flow Rate	118
8.8.2. Constant Pressure (Outlet)	118
8.8.3. Constant Linear CC Speed (Outlet)	118
8.8.4. Programmable Flow Rate	118
8.8.5. Programmable Pressure (Outlet)	118
8.8.6. Programmable Linear CC Speed (Outlet)	119
8.8.7. At Ignition, *2 Plus Addition	120
8.8.8. At Ignition, *3 Plus Addition	120
8.8.9. At Ignition, +20 (+40) Plus Addition	120
8.8.10. At Ignition, Reduce by Half	121
8.8.11. At Ignition, Reduce to 10	121

8.8.12.	At Ignition, Turn Off	121
8.8.13.	Flowmeter	121
8.8.14.	Economy	121
8.8.15.	Split Ratio	121
8.8.16.	At Ignition, *4.3	123
8.8.17.	At Ignition, Reduce by 2.5 Times	123
8.8.18.	Constant Pressure (Inlet)	123
8.8.19.	Constant Linear CC Speed (Inlet)	123
8.8.20.	Programmable Pressure (Inlet)	123
8.8.21.	Programmable Linear CC Speed (Inlet)	123
8.8.22.	Flame Detection Level	123
8.9.	Temperature Zones	124
9.	Troubleshooting	125
9.1.	Restarting the Device in Case of Error	125
9.2.	Device Connection Error	126
9.3.	Debugging Using the Operation Log	127
10.	Program Identification	128
10.1.	Receiving the Program ID	128
10.2.	Calculation Module Control	128

1. Introduction

The Chromos software (Chromos SW therefore) is designed to collect and process chromatographic data, control chromatographs, samplers, maintain a database of all analyzes in the laboratory or on the shop floor. Chromos SW is compatible with the following devices:

- Chromos GC-1000
- Chromos LC-301
- Chromos MRM-10
- Chromos LAS-23
- Chromos HSS-A
- Chromos HSS-A2
- Chromos ADC-2M
- HT1500L, HT3100A Samplers
- Valco Valve
- Chromos Cryo

Chromos SW provides simple and convenient use and minimizes operator's actions to obtain the desired result. You can extend the capabilities of Chromos SW using plug-ins of additional calculations. Installation files and documentation for plug-ins is available on the Internet at kb.has.ru/soft:dopolnitelnye_raschjoty.

This manual is intended for general public users performing chromatography with Chromos devices. It includes an overview of Chromos SW, operating procedures, and a brief guide on the main actions and commands to collect and process chromatographic data.

«Chromos Engineering» wishes you success in using Chromos SW and in your work!

Table 1: Contact us

Address:	606000, 16 Lermontov St., Dzerzhinsk, Nizhny Novgorod Region, Russia
Telephone/fax:	8 (8313) 249-200, 8 (8313) 249-300
Website:	http://www.has.ru/
E-mail:	support@has.ru

Note: Chromos SW updates are available on the Internet at: kb.has.ru

Note: E-mail your suggestions and comments on the software to: soft@has.ru

2. Terms and Conditions

These Terms and Conditions (“Agreement” therefore) are a legal document concluded between you (a legal entity) and the Chromos Group regarding the Chromos software, including software recorded on relevant media, any printed materials, any “embedded” or “electronic” documentation. The “Software” also includes any updates and additions to the software originally provided by the Chromos Group.

The program is protected by copyright laws and international treaties, as well as other laws and agreements governing the copyright relations.

By installing, copying, downloading, accessing or otherwise using this program, you hereby accept the terms and conditions of this Terms.

If you disagree with the terms and conditions of this Agreement, you shall not install or use this software, and shall return it to the Vendor and receive your payment back.

License Scope.

The Chromos Group grants you the following rights, subject to your compliance with all the terms and conditions of this Agreement:

You may install and use one copy of the software on one computer, which can be a workstation, terminal, or any other digital electronic device.

You may also store or install a copy of the program on a data storage device (such as a network server) designed and used solely to start and run the program on your other computers within the local network; however, you shall obtain a separate license for each computer, on which the program is installed, used, or displayed, or from which it runs. The program license is indivisible and does not allow to use the program simultaneously on several computers.

Other Rights and Restrictions.

Never reverse engineer this technology or decompile the software. The program shall never be provided for temporary use.

On one occasion, the original user of the program may transfer all their rights under this Agreement and the program itself directly to another party for use. Such transfer shall involve the entire program (including all components, media and printed materials, any updates, this Agreement and the certificate of Authenticity, if available). Such transfer shall not be made indirectly or through a third party. The party receiving the program as a result of such one-time transfer shall agree to all terms and conditions of this Agreement, including the obligation not to transfer the program and the license to anyone else.

The program is delivered “as is”. The program authors and owners provide no warranties, express or implied, regarding the program, and bear no responsibility for any obvious, accidental, indirect or other damage resulting from the use, possession or inability to use or possess the program.

The Chromos Group has the right to terminate this Agreement should you fail to comply with its terms and conditions. In this case, you shall destroy all and any copies of the software and its

components in your possession.

Updates.

To use an update to the software, you need to have a license for the Chromos software. After update, it is prohibited to use the old software.

Copyright.

All proprietary rights and copyrights to the program (including but not limited to any graphic images, photographs, animations, video recordings, audio recordings, music, text and additional programs), the contents of accompanying printed materials and any copies of the program belong to the Chromos Group and its suppliers. All proprietary rights and copyrights in and to the content accessed through the program belong to the content copyright owner and are protected by copyright laws and international treaties. This agreement grants you no rights to access the content. The Chromos Group reserves all and any rights not expressly granted by this Agreement.

Various Program Media.

The software can be delivered on several types of media. Regardless of their type and capacity, you can use only one type of media compatible with your computer or network server. It is prohibited to install or use the product on other computers from additional copies provided on other media. It is prohibited to provide additional copies for temporary use or transfer them to other parties, except for a complete software transfer as described above.

Backup Copy.

After installing one copy of the software as stipulated in this Agreement, you may retain the original media on which the software was provided to you by the Chromos Group for the sole purpose of archiving or storing the backup copy. If you require the original media in order to use the software on your computer, you may make one copy of the software solely for backup or archiving purposes. It is prohibited to make copies of the software and accompanying printed documentation unless expressly stated so in this Agreement.

3. Hardware Requirements

- INTEL Pentium Dual-Core or higher
- Windows 7 or higher
- RAM: 4 GB
- HDD: 250-500 GB
- Monitor 1280x1024
- Optical drive or USB (to install from media)
- COM-ports – one per each device
- Mouse
- Speakers (optional)
- Printer (optional)

Note: For «Chromos GC-1000» chromatographs released before November 2016 (serial number lower than 1629) and for «Chromos LC-301» chromatographs with the APM-2M module version 2.x, a COM-port extension board is required with a PCI slot (not PCI-express).

Warning: On Hewlett-Packard or Dell PCs, the operation of PCI-express COM-port extension boards is unstable. Select a model with a PCI slot or use motherboard COM-ports. The issue is described [here](#).

4. Installing the Software

Chromos SW installation file is either delivered on optical media or a flash drive or downloaded from the website kb.has.ru.

To install Chromos SW on your computer, do the following:

1. Run the installation file *AutoRun.exe*
2. Click **Install Chromos**.
3. Select the components you want to install. Full installation is selected by default (Fig. 1).

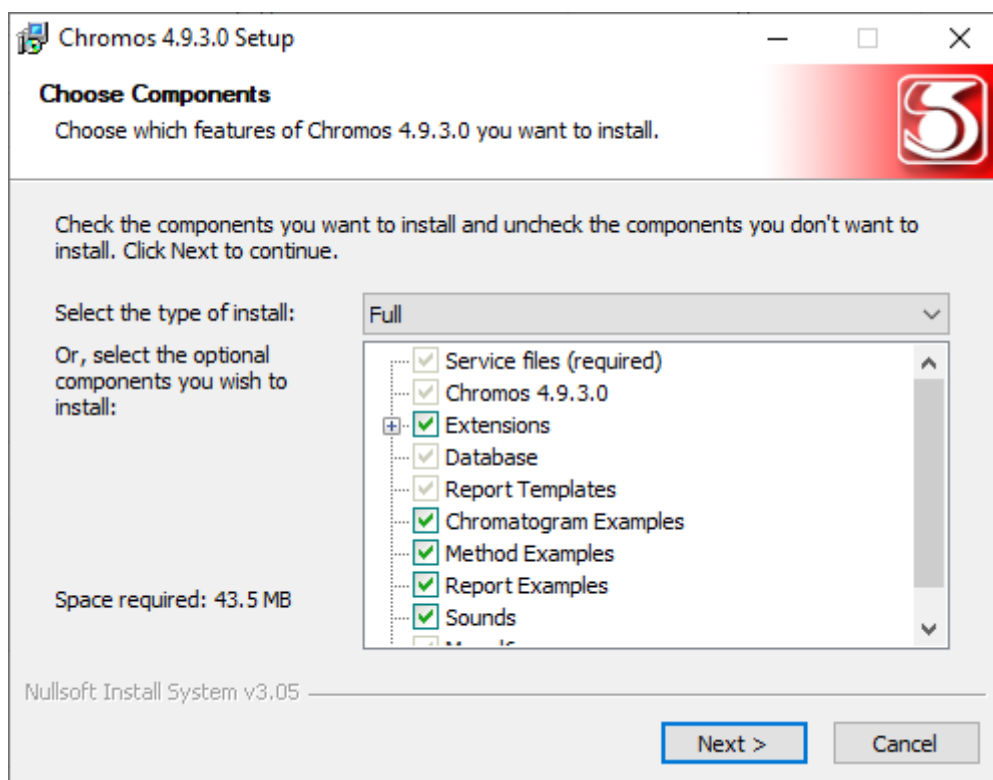

Fig. 1: Selecting system components to install

4. Click **Next**.
5. (Optional) Specify the software installation folder.
6. Click **Install**.
7. When installed, click **Finish**.

Note: Chromos SW updates are available on the Internet at: kb.has.ru

5. «Chromos 4» Overview

5.1. Key Concepts

This section provides a list of key concepts used in this manual.

Basic concepts of chromatography

- Absolute calibration method is the determination of the amount of a component in a sample according to a previously obtained calibration curve.
- Baseline drift is the change of the signal of the chromatogram baseline in time.
- Baseline is an imaginary line under the peak, connecting its beginning and end. It is used for calculating peak parameters.
- Blank run is a procedure for analyzing a substance or material without an analytical sample or with a blank sample.
- Calibration curve is a curve that shows the relationship between the magnitude of the detector response (peak area or height) and the amount of the component in the sample.
- Calibration is the determination of calibration dependencies between the indications read off the scale and the corresponding values of the measured quantity.
- Chromatogram baseline is the background detector response, recorded on the chromatogram without introducing a sample into the chromatographic column.
- Chromatogram is a graphical representation of a detector signal, reflecting a change in substance concentration over time. A chromatogram consists of a baseline (zero line) and peaks. The identification of peaks in a chromatogram is affected by a resolution factor.
- Chromatograph is a device for chromatographic study. There are gas, liquid, process chromatographs.
- Chromatography is a method to separate and analyze mixtures based on a different distribution of their components between two phases, stationary and mobile (eluent). Chromatography can be based on a different capacity of components for adsorption (adsorption chromatography), absorption (partition chromatography), and ion exchange (ion-exchange chromatography). Chromatographic separation can be carried out in tubes filled with sorbent (column chromatography); in capillaries, whose walls are coated with sorbent (capillary chromatography); on plates covered with a sorbent bed (thin-layer chromatography); on paper (paper chromatography). Depending on the aggregate state of eluent, gas or liquid chromatography are distinguished.
- Column is a device for separating a multicomponent mixture of substances. There are capillary and packed columns. In capillary columns, the mobile phase moves through thin tubes whose inner surface is coated with the stationary phase (bonded phase). In packed columns, the mobile phase passes through sorbent which fills the column inside. Sometimes columns may have ovens.
- Component is a substance in a sample that is determined by a chromatographic analysis. Sometimes the term *Component* refers to a compound, which is a substance made up of two or more different chemical elements combined in a fixed ratio.
- Dead time (void time) is the time it takes to go from the column inlet to the detector. During dead time there can be no representative peaks.
- Detector is a device designed to measure and detect components in mobile phase flow.
- Gas flow regulator is an electronic device that controls the supply of carrier gas to the column.
- Identification window is the peak search range in time.
- Injection valve is a device for injecting a sample under pressure. Injection valves differ in the number of strokes and have two positions: “load” and “inject”.

- Injector is a device designed to evaporate a liquid sample before it is introduced into a chromatographic column.
- Integration events are the actions performed at a specified time when marking peaks (for example, enable/disable marking, merge peaks, etc.)
- Internal normalization method is the determination of the amount of the component in the sample in relation to its peak to the total signal, which in total is taken as 100%.
- Internal standard is a compound, a known amount of which is added to the analyzed sample in order to eliminate the need to measure the size of the sample in quantitative analysis.
- Internal standard method is the determination of the amount of a component in a sample by adding a known amount of another substance to the analyzed mixture and comparing the peak of the known component with the peaks of the unknown.
- Isotherm (sorption isotherm) is the dependence of the concentration of a substance in the stationary phase on its concentration in the mobile phase at a constant temperature. The isotherm plot correlates with the peak curve (Fig. 2).

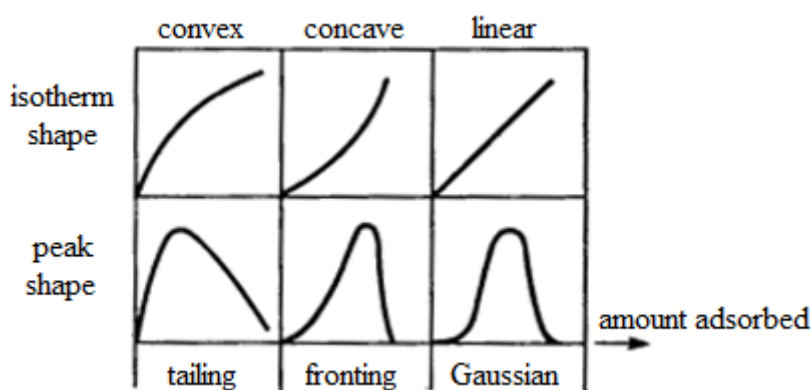

Fig. 2: Dependence of the isotherm plot on the peak curve

- Limit of detection is the minimum concentration of an analyte that can be detected by the detector.
- Negative peak is a peak whose baseline is above the peak-generating curve.
- Noise is the high-frequency oscillations of the chromatogram baseline.
- Normalization method with correction factors is the determination of the amount of a component in a sample by taking the sum of the areas of all peaks, taking into account the coefficients, equal to 100%. This method applies detector sensitivity correction factors to the components.
- Oven is a device for maintaining a certain temperature.
- Peak area is the area of the chromatogram within the boundaries of the baseline under the peak and the curve describing this peak.
- Peak height is the distance between the baseline and the top of the peak.
- Peak identification is the assignment of peaks on the chromatogram to a certain component in the table according to retention parameters.
- Peak integration is the peak marking; it is the determination of peaks baselines and the measurement of their parameters (retention time, area, height).
- Peak is a curve, ideally approaching the normal (Gaussian) distribution curve, reflecting the increase and decrease in substance concentration at the column outlet. It is characterized by height, width, area, retention time, and sometimes by asymmetry which is calculated by a special formula. This Manual also uses such terms as reference peak, shoulder, negative peak, and unsplit peak.
- Phase is part of a thermodynamic system with homogeneous chemical composition and physical properties, separated from other parts (phases) with different properties by interfaces

where changes of properties take place. There are mobile and stationary phases in chromatography. The principle of chromatography is based on their interaction.

- Quantitative determination (quantitative measurement) is the final stage of analysis, at which the concentrations of components in a sample with an unknown content of the analyzed components are calculated. The measurement of concentration is based on the proportionality between the amount of a substance and the height or area of a peak in a chromatogram. The calculation can be performed by absolute calibration, internal standard or normalization. For more information on scoring methods, see [Sec. 8.6. Standard Method Calculations](#).
- Reference peak is a peak corresponding to the label substance, relative to the retention time of which the retention times of other non-reference peaks are calculated.
- Reference substance (standard substance) is a compound with a known retention time added to a sample to help identify sample components.
- Resolution factor is a parameter characterizing the separating power of the column.
- Response factor is a factor of sensitivity of the detector to the component.
- Retention index is the dimensionless quantity characterizing the position of the peak of a substance in the chromatogram relative to the peaks of the selected standards. If n-alkanes are used as standards, then the retention index is called the Kovats index.
- Retention time is the time elapsed from the sample injection into the column until the peak maximum was reached.
- Sample is the mixture to be analyzed that is injected into the column.
- Sampler is a device for measuring and injecting a specific amount of a sample.
- Selectivity factor is a parameter characterizing the separating power of the column.
- Shoulder is a peak on the tail of a larger peak. [Fig. 3](#) shows peak 2 area which is smaller than peak 1 area, so peak 2 is considered a shoulder.

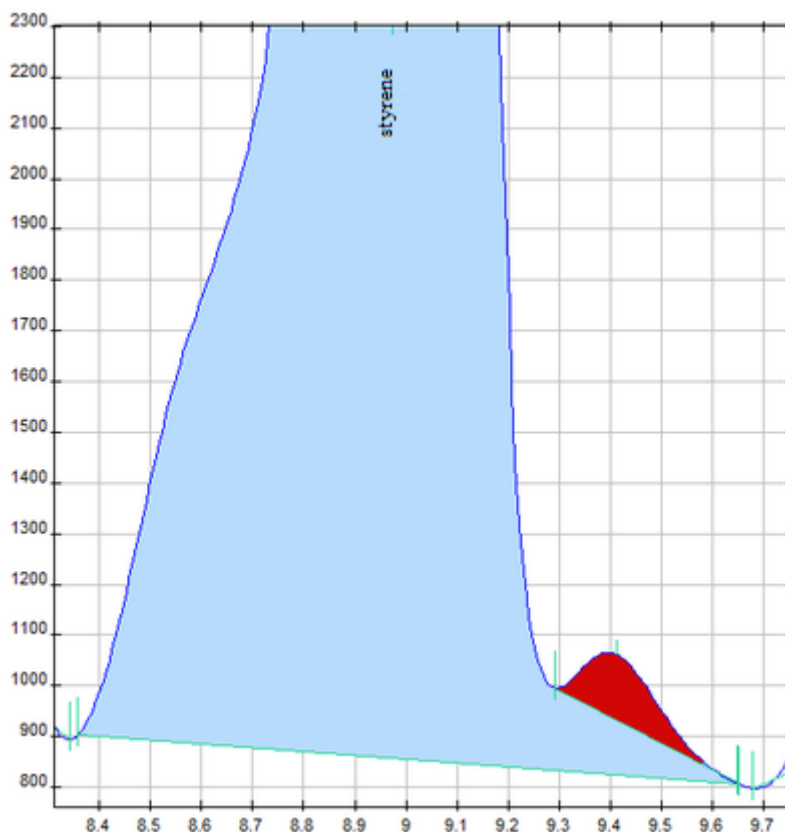

Fig. 3: Shoulder

- Switching valve is a device for switching chromatographic columns, elements of gas circuits during analysis, etc.
- Theoretical plate is a theoretical distance required for the solute adsorption-desorption between the stationary and mobile phases. The number of plates represents the efficiency of a chromatographic column: the higher the number, the better the separation quality of a multi-component mixture.
- Unmeasurable component is a component that cannot be detected by the detector.
- Unsplit peak is a peak additional to any peak whose baseline it shares.

Concepts of Chromos SW

- Channel is a chromatogram recording channel.
- Device is a device connected to a computer on which the software is installed.
- Method is a set of procedures used in chromatographic study for chromatograph operation, quantitative calculations and chromatogram processing.
- Passport a form for recording data on the chromatogram, sample and analysis conditions.
- Plug-in is a software extension. Plug-ins are extensions of additional calculations.
- Report is the visualization of the results of the performed analysis.
- Verification is a procedure for determining the error of measuring devices and establishing their suitability for use and compliance with the accuracy class.

For abbreviations and acronyms, see [Sec. 8.1. Abbreviations and Acronyms](#). For the operating principle of a chromatograph, see [Sec. 8.4. Chromatograph Workflow](#).

5.2. Program Structure

5.2.1. Main Program Components

Chromos SW has two main items: the *Method* and the *Chromatogram*.

The *Method* is required to obtain a chromatogram. It describes the operating modes of a chromatograph, quantitative calculations, conditions for receiving information, and further processing of the obtained chromatogram, as well as the calculation of concentrations and the issuance of a chromatogram report.

The *Chromatogram* includes a chromatogram plot with peak marking, if the chromatogram has any marking, a peak table that indicates peak exit time, height, area, presence of a reference peak, concentration, units of measurement, and name. If some peaks are grouped together, the table shows total height, area, and concentration for each group.

At the early stage, when configuring the procedure, the operator creates a new method and sets all the necessary parameters for data collection, automatic marking, identification, and quantitative calculation. In everyday work, using the already configured method, the program automatically records the chromatogram and makes all the necessary calculations. Therefore, the configured method helps fully automate the chromatographic analysis.

To automate the operation of devices, use scheduler. For more details on scheduling, see [Sec. 6.12. Scheduling](#).

When running Chromos SW, additional calculation modules (plug-ins) are also being loaded, if they have been installed. For more details about the additional calculations, see kb.has.ru/soft:dopolnitelnye_raschjoty.

5.2.2. Program Window

The program window (Fig. 4) includes the following items:

- Menu
- Control panel
- Workspace
- Status bar

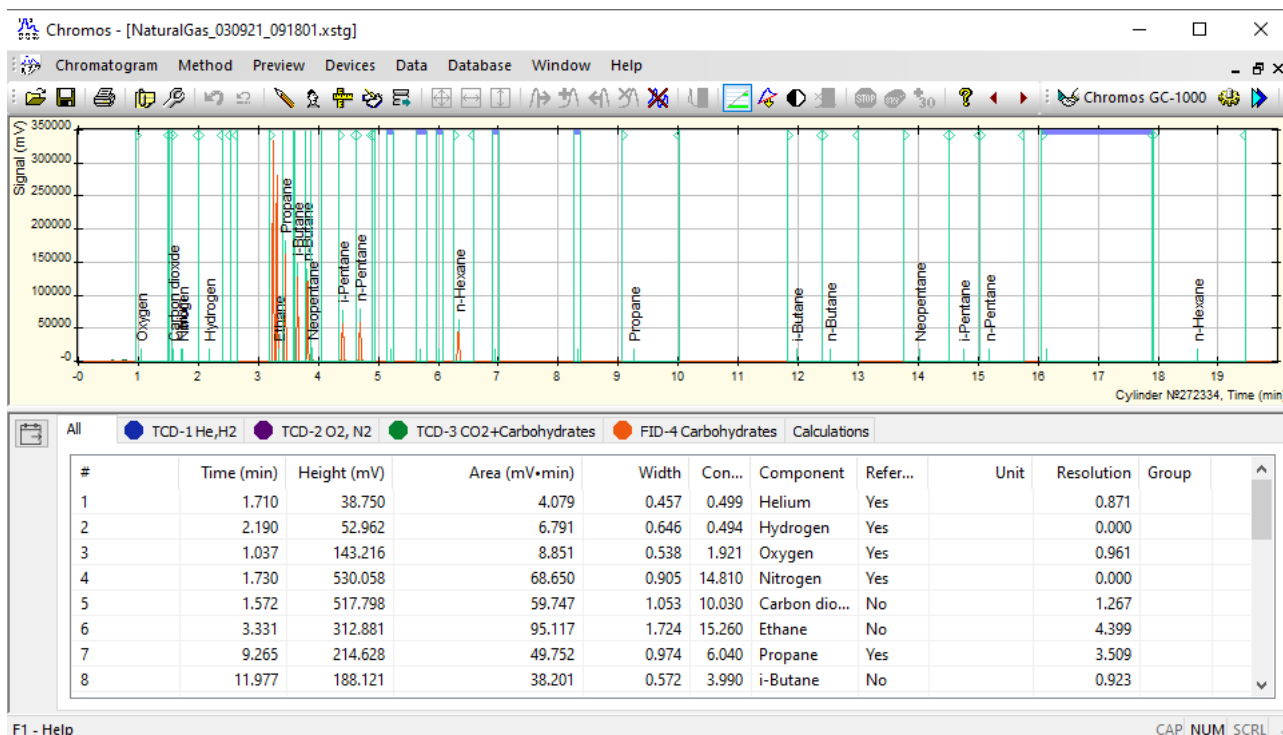

Fig. 4: Program window

The menu contains program controls. For more details on the menu items, see [Sec. 5.2.3. Menu System](#).

The control panel displays the connected devices and icon buttons to work with the chromatogram. For the icon table, see [Sec. 5.2.5. Control Panel](#).

A chromatogram window opens in the workspace. For more details on the chromatogram window items, see [Sec. 5.2.4. Chromatogram Window](#).

The status bar displays brief descriptions of tools (when the cursor is pointed to a relevant icon on the control panel) and indicators of locking keys from the keyboard (Caps Lock, Num Lock, Scroll Lock).

5.2.3. Menu System

The Chromos SW menu system consists of the following items:

- Chromatogram
- Method
- Preview
- Devices
- Data
- Database
- Window
- Help

The menu items allow to control the program, work with chromatogram and method files, connect and verify devices, and analyze data. The menu items have the following applications:

- The *Chromatogram* menu includes basic functions (Open, Save), general program settings, user controls, print settings, chromatogram passport, and report parameters.
- The *Method* menu includes chromatogram controls.
- The *Preview* menu (active when a chromatogram is open) allows to configure the chromatogram plot display and hide non-reference peaks.
- The *Devices* menu allows to connect and control devices.
- The *Data* menu includes filter, marking, peak identification, and calculation tools. The menu also contains the program extension editor and instrument verification tools.
- The *Database* menu contains functions to work with the database, calibration mixture editor, and data table controls (analyses, operators, columns, etc.).
- The *Window* menu allows to configure the chromatogram window display in the workspace and switch between chromatograms.
- The *Help* menu includes this Manual, the Terms and Conditions, and the Operation Log.

5.2.4. Chromatogram Window

The chromatogram window (Fig. 5) includes a chromatogram plot with peak marking, if the chromatogram contains any marking, a peak table that indicates peak data such as exit time, height, area, presence of a reference peak, concentration, units of measurement, etc.

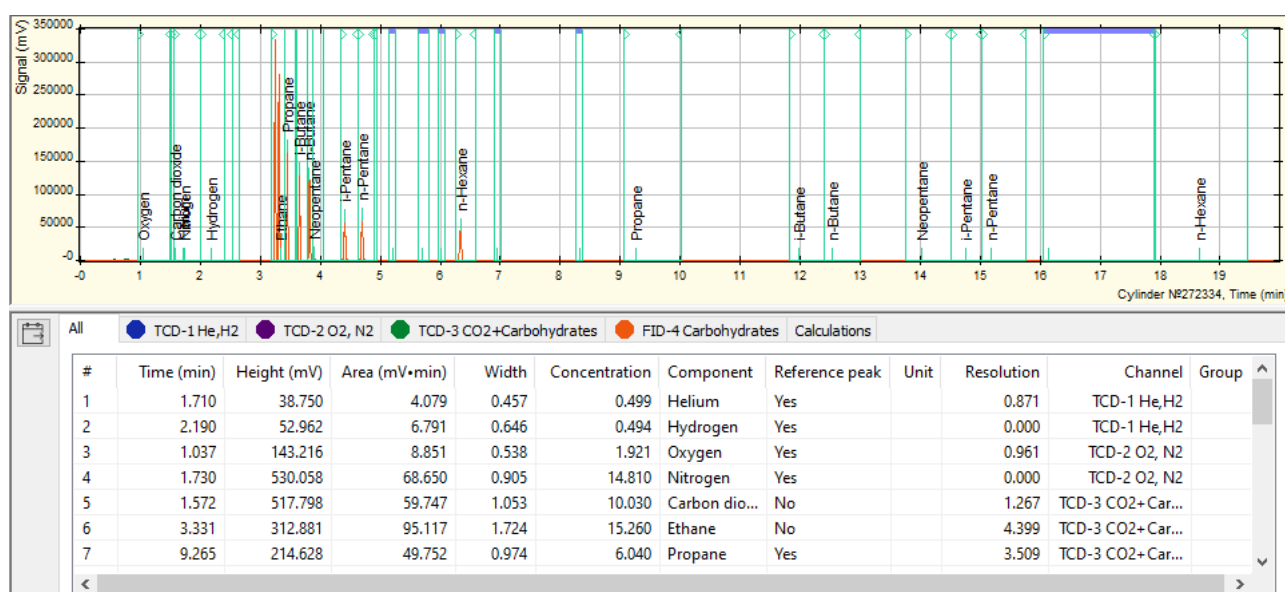

Fig. 5: Chromatogram window and Peak table

Some columns in the peak table are not displayed by default. Right-click to configure the display

of the following columns:

Table 2: *Peak table data*

Column	Data
#	Sequence Number
Time (min)	Peak exit time
Height (mV)	Peak height (mV)
Area (mV·min)	Peak area (mV·min)
Width	Peak width
Concentration	Component concentration
Component	Component
Reference peak	Reference peak indicator
Max	Maximum peak height
Unit	Units of measurement
Theor. plates	Theoretical plates
Theor. plates per meter	Theoretical plates per meter
Asymmetry	Tailing factor
Normalization	Number for rapid monitoring of substance concentration (based on direct proportionality of peak area and concentration)
Resolution	Resolution factor of two adjacent peaks in a chromatogram
Width at half height	Full width at half maximum (width at half height)
Channel	Channel
Group	Group
Show Groups	Show groups option
Hide Groups in Calibration Chromatograms	Hide groups in calibration chromatograms option
Show Only Current Channel	Show only current channel option

Some of the above data can be entered manually. For example, you can manually enter the component name and concentration in the peak table (such editing is required to calibrate the instrument – see [Sec. 6.28.3. Recording Calibration Chromatograms](#)).

























If some peaks are grouped together, the table shows total height, area, and concentration for each group. Groups are colored light green in the peak table. In addition, the group has no data in # and *Time* boxes.

If concentration limits are indicated in the database and if concentrations of any substances exceed these limits, this line will be colored light pink.

5.2.5. Control Panel













The control panel displays the connected devices and icon buttons to work with the chromatogram. The following table shows the functions represented by the icons:

Table 3: *Toolbar items*

Icon	Name	Action
	Open	Open a chromatogram
	Save	Save a chromatogram
	Print	Print a chromatogram
	Passport	Open the <i>Passport</i> window
	Method	Open the <i>Method</i> window
	Undo	Cancel a data change
	Undo Zoom	Cancel zoom action
	Reintegrate	Automatically redo the marking with given parameters
	Identify Peaks	Identify peaks according to the parameters (selected in <i>Method > Calibration</i>)
	Calculate Concentrations	Calculate substance concentrations according to the parameters (selected in the <i>Method > Calibration</i>)
	Report	Open the <i>Report Parameters</i> window and generate a chromatogram report
	Export	Export a chromatogram
	Show All	Show the entire chromatogram
	All by Time	Show all by time
	All by Height	Show all by peak height
	Add Unsplit Left Peak	Add an unsplit peak on the left
	Add Peak	Add a peak
	Add Unsplit Right Peak	Add an unsplit peak on the right
	Delete Peak	Delete the selected peak
	Delete All	Clear all peak marking
	Events	Add an event at a specific chromatogram interval
	Display Groups	Show/hide peak groups in the peak table
	Drift Compensation	Compensate for a drift in accordance with the selected method (the method is selected in <i>Chromatogram > Options > Other...</i> ; see Sec. 5.3.5. Other... Tab)
	Hide Unidentified Peaks	Hide unidentified peaks

continues on next page

Table 3 – continued from previous page

Icon	Name	Action
	Cut Section	Cut out a section from the initial chromatogram (the function is irreversible!)
	Stop Recording	Stop recording on the selected channel
	Stop Series Recording	Stop recording a series of analysis
	Increase Analysis Time	Increase recording time by 30 minutes
	User Manual	Open the <i>Help</i> window
	Previous Analysis	Navigate to the previous analysis in the series
	Next Analysis	Navigate to the next analysis in the series
	Connect/Disconnect	Connect or disconnect the device
	Configuration	Open the <i>Configuration</i> window
	Scheduler	Schedule analyses to start automatically
	New Series	Create a new series of analysis
	Start Analysis	Start a new analysis in the series

5.2.6. Calibration and Conventional Chromatograms

Chromos SW has two types of chromatograms: conventional and calibration (Fig. 6). In calibration chromatograms, you can change the name of components and set their concentrations. For calibration chromatograms, the operator needs to select the *Calibration* check box in the chromatogram passport.

Visually, a calibration chromatogram differs from a conventional one by field color behind the chromatogram. If the field color is yellow, this is a calibration chromatogram. If the field color is white, this is a conventional chromatogram.

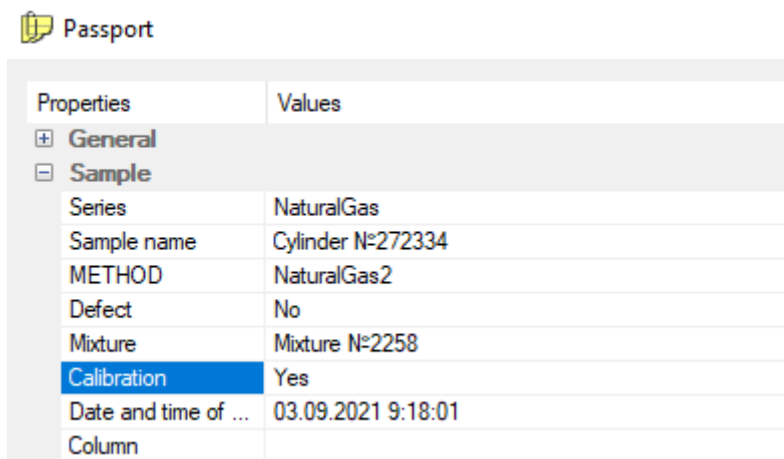

Properties	Values
⊕ General	
⊖ Sample	
Series	NaturalGas
Sample name	Cylinder N°272334
METHOD	NaturalGas2
Defect	No
Mixture	Mixture N°2258
Calibration	Yes
Date and time of ...	03.09.2021 9:18:01
Column	

Fig. 6: Calibration check box

Calibration chromatograms are used to plot a calibration. The calibration procedure consists of finding calibration factors from chromatograms with a known content of components. A calibration can only be plotted using calibration chromatograms.

For more details on calibration, see [Sec. 6.28. Chromatograph Calibration](#) and [Sec. 6.28.1. Plotting a Calibration](#).

5.3. Options

In *Chromatogram > Options*, you can configure parameters to work with Chromos SW. Below is a description of tabs and parameters that can be configured in this window.

5.3.1. View Tab

The *View* tab (Fig. 7) has the following parameters:

- Values format – configures the appearance of the displayed analysis results:
 - Float
 - Exponential
 - Select automatically
- Number of decimal places – configures the number of decimal places in peak responses, in component concentrations, height, and area values:
 - Time (peak table and report)
 - Concentration
 - Height
 - Area
- Show groups – if this checkbox is selected, a peak group row is displayed in the results table below the chromatogram
- Hide groups in calibration chromatograms – selecting this checkbox prohibits the display of a peak group row in the results table under the calibration chromatogram;
- Peak Names – configures the display of inscriptions above the peaks in the chromatogram and their position:
 - Number
 - Name
 - Exit time
 - Index
 - Horizontal
 - Vertical
- Peak Marking – configures the peak marking appearance:
 - Vertical line – the peaks are marked with a vertical line;
 - Line section – the peaks are marked with a section;
 - Save marking – selecting this checkbox saves the marking;
 - Show method peak exit windows on chromatogram – selecting this checkbox displays peak exit gaps (blue bar) in the chromatogram.

5.3.2. Warnings Tab

The *Warnings* tab (Fig. 8) has the following parameters:

- Warn about device disconnection – selecting this checkbox enables a warning about instrument shutdown.
- Warn about recording stop – selecting this checkbox enables a warning about a stop of chromatogram recording.

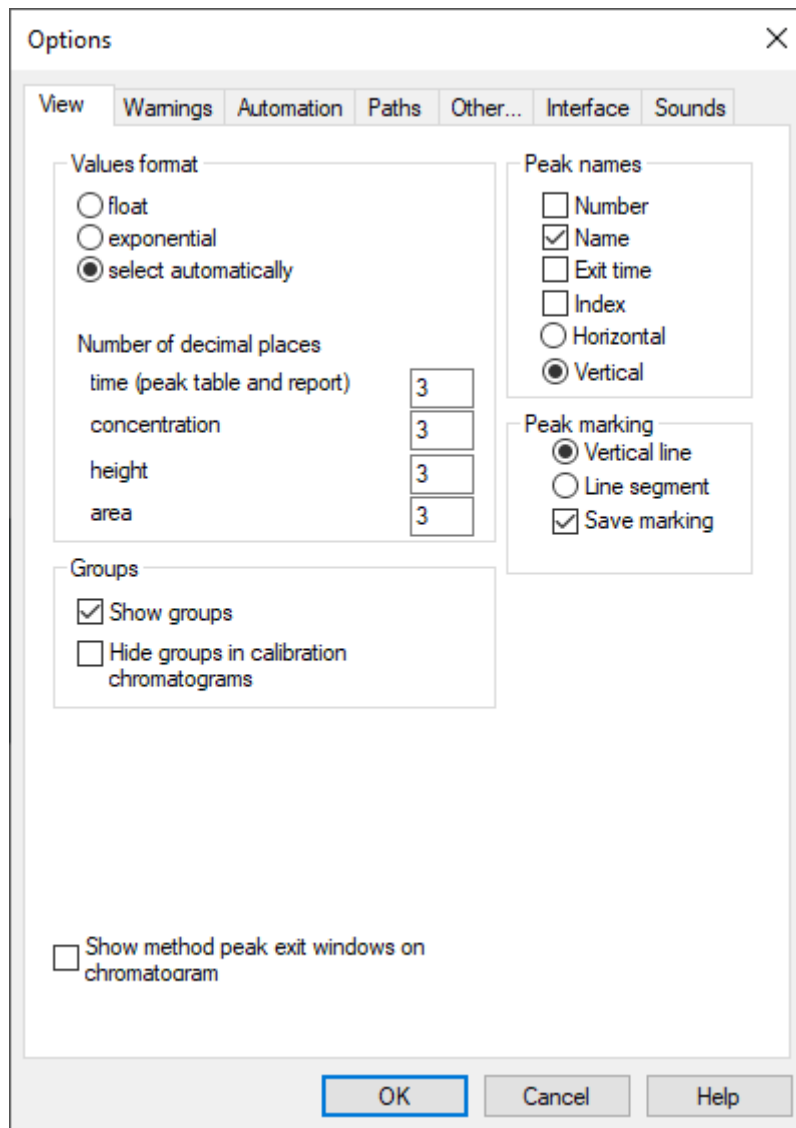

Fig. 7: Options > View

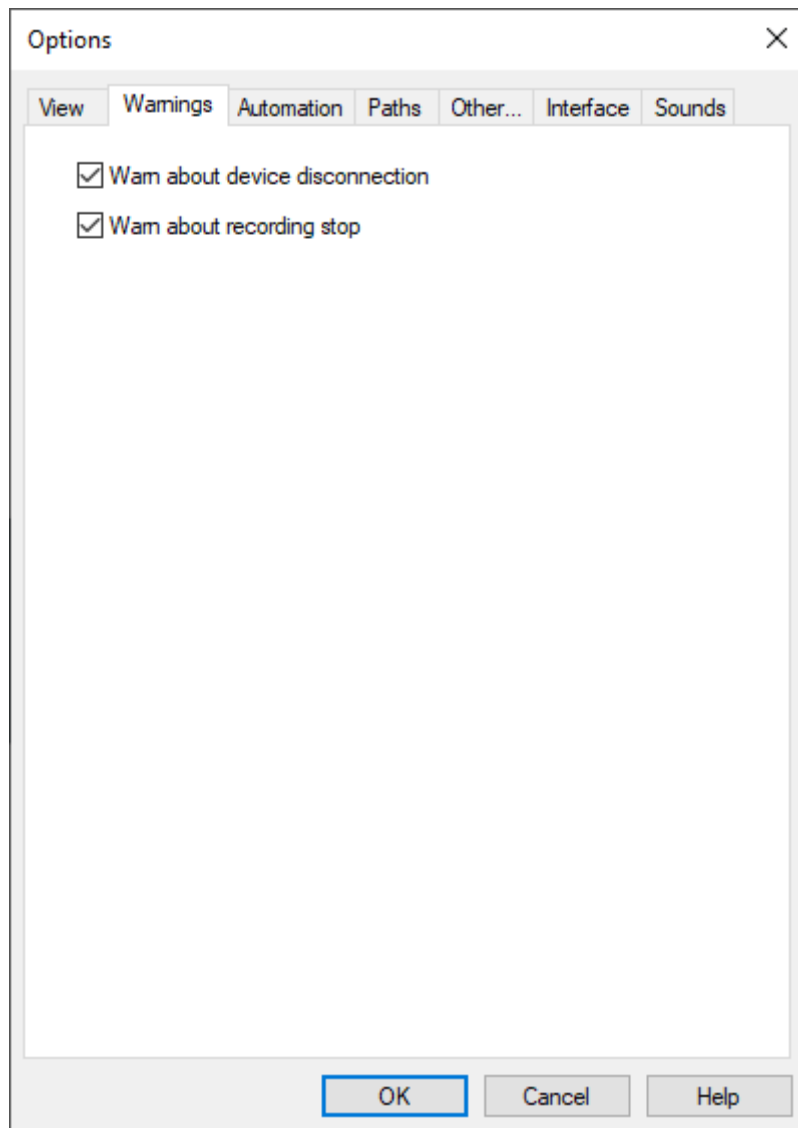

Fig. 8: Options > Warnings

5.3.3. Automation Tab

Selecting the checkbox enables the following actions for existing settings in the *Automation* tab (Fig. 9):

- Display Passport during launch preparation — this option opens the *Passport* window to fill it in during startup preparation.
- Save the chromatogram automatically — after the recording ends, the chromatogram is saved automatically to the disk under the name selected by the program.
- Close the chromatogram automatically — after the recording ends, the recorded chromatogram closes automatically.
- Show Report — enables the display of the *Report* window to configure it by pressing a button on the control panel.
- Display notches on vertical peaks in the report — enables the display of ticks on vertical peaks in the report.
- Show Auto-marking — enables the display of the *Auto-marking* window to configure it by pressing a button on the control panel.
- Show missing method warning — enables the display of a warning about the missing chromatogram method when opening the chromatogram.
- Generate an empty method if missing — enables the creation of a new method when the desired chromatogram method is missing.

5.3.4. Paths Tab

The *Paths* tab (Fig. 10) has the following parameters:

- Save copies of chromatograms to... — selecting this checkbox activates the field where a path can be indicated to save chromatogram copies.
- Database location — the field is used to specify a path to save the database.
- Method files location — the field is used to specify a path to save methods.
- Chromatogram files location — the option to specify a path to save chromatograms.
- Report templates location — the field is used to specify a path to the location of report templates.
- Save new chromatograms by... — the field to select a determining factor of the path to save chromatograms from the list.
- Shared folder
- Year/Month
- Method
- Method/Year/Month
- Year
- Year/Month/Day
- Series/Year/Month/Day
- Chromatogram file name template — the field to select a chromatogram name template from the list or to enter it manually:
 - station — sampling place;
 - place — sampling point;
 - operator — operator;
 - method — method;
 - type — calibration or conventional type of a chromatogram;
 - sample — sample;
 - count — numbering;
 - year (00-99);

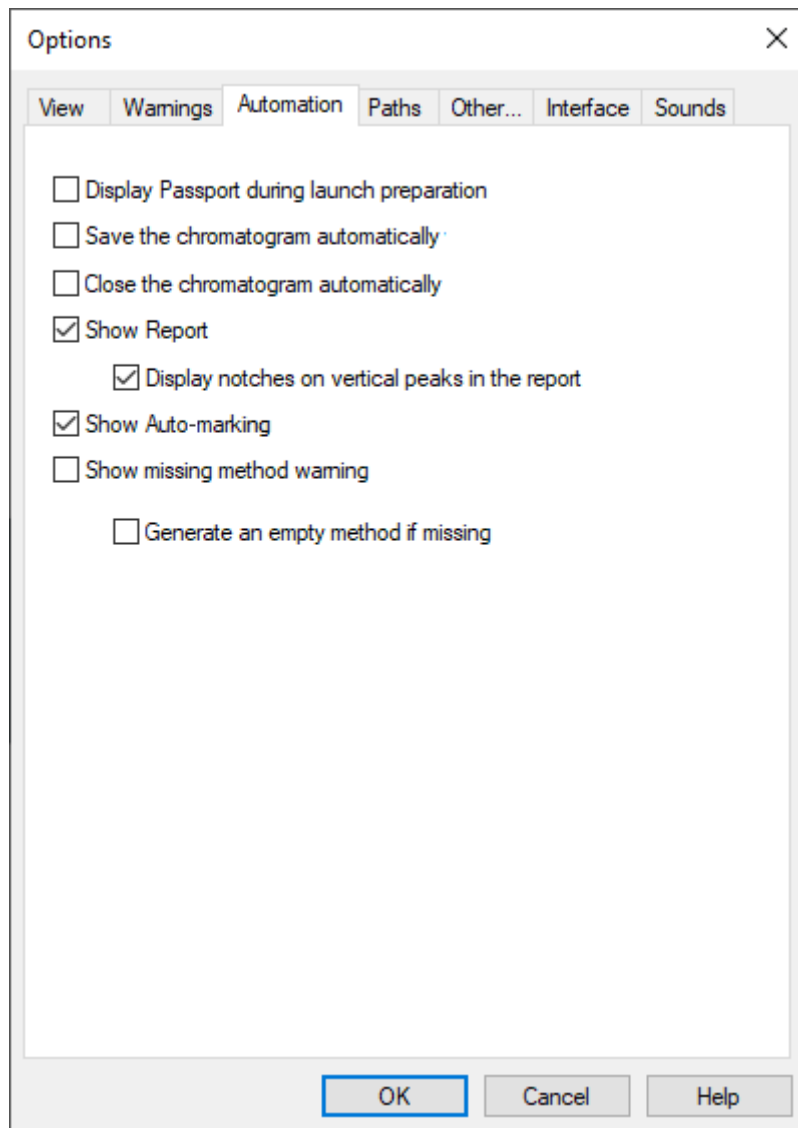

Fig. 9: Options > Automation

- month (01-12);
- day (01-31);
- hour (00-23);
- minute (00-59);
- second (00-59);
- uuid – number in the database.

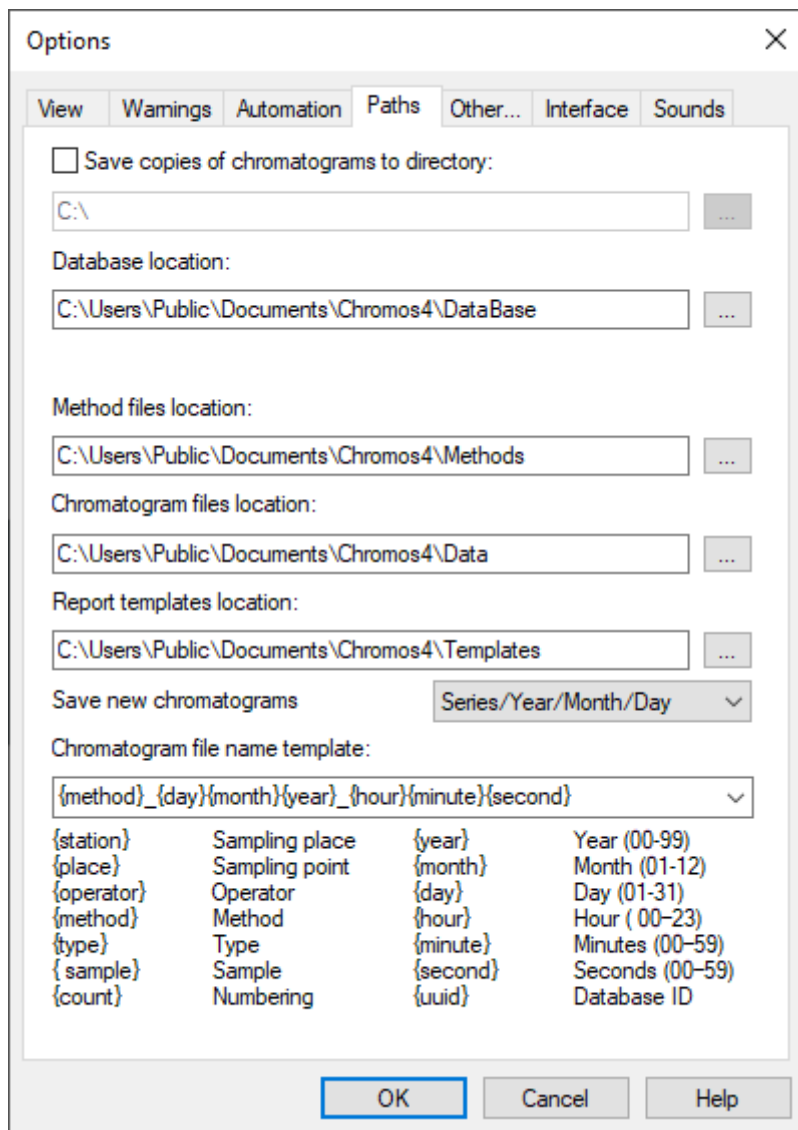

Fig. 10: Options > Paths

5.3.5. Other... Tab

The *Other...* tab (Fig. 11) has the following parameters:

- Drift compensation – determines the drift compensation option, using the switch.
- By labeled baseline – the baseline and unmarked chromatogram sections are converted to zero.
- By endpoints – only start points and end points are converted to zero, while intermediate points are shifted relative to the line from the start point to the end point.
- CPU load – controls the update rate of information in the program.
- Use sounds – selecting this checkbox activates sounds to indicate chromatograph status: instrument readiness, analysis start/stop;

- Save chromatogram sources – selecting this checkbox enables saving the chromatograms source files;
- Program version – allows to select a regular program version or a special version without notifications.

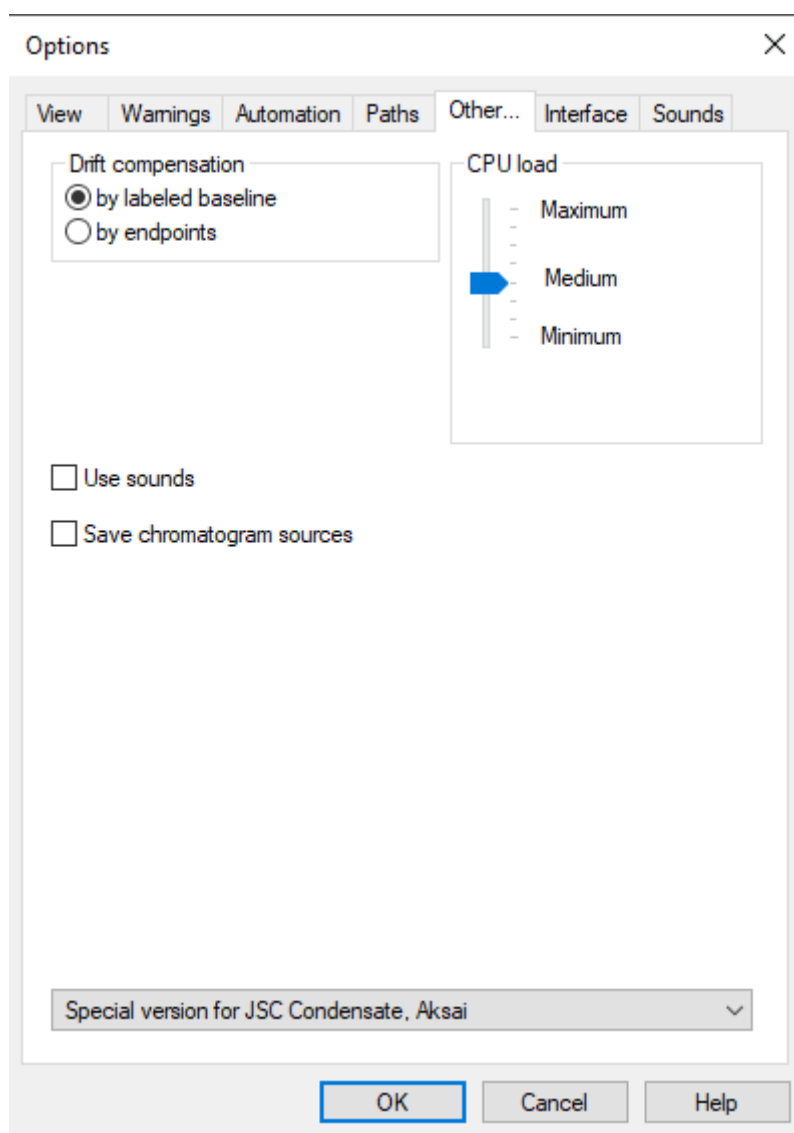

Fig. 11: Options > Other...

5.3.6. Interface Tab

The *Interface* tab (Fig. 12) has the following parameters:

- Graph color;
- Background color;
- Grid color;
- Baseline color;
- Peak caption color;
- Chart background;
- Color of the plot of an overlaid chromatogram;
- Reset to recommended defaults.

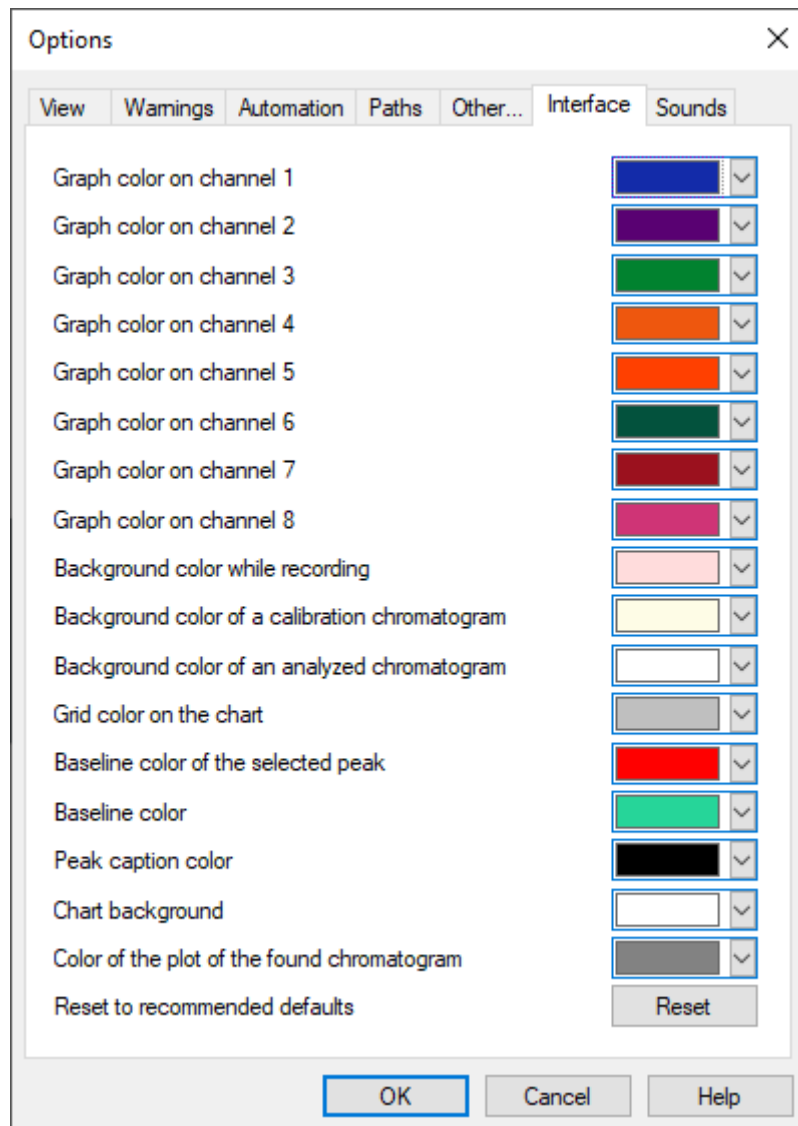

Fig. 12: Options > Interface

5.3.7. Sounds Tab

The *Sounds* tab (Fig. 13) has the following parameters:

- Sound scheme — you can select the scheme from a list, delete it, or save a new scheme;
- Sounds — you can select a sound from a list, browse for a sound, and check it.

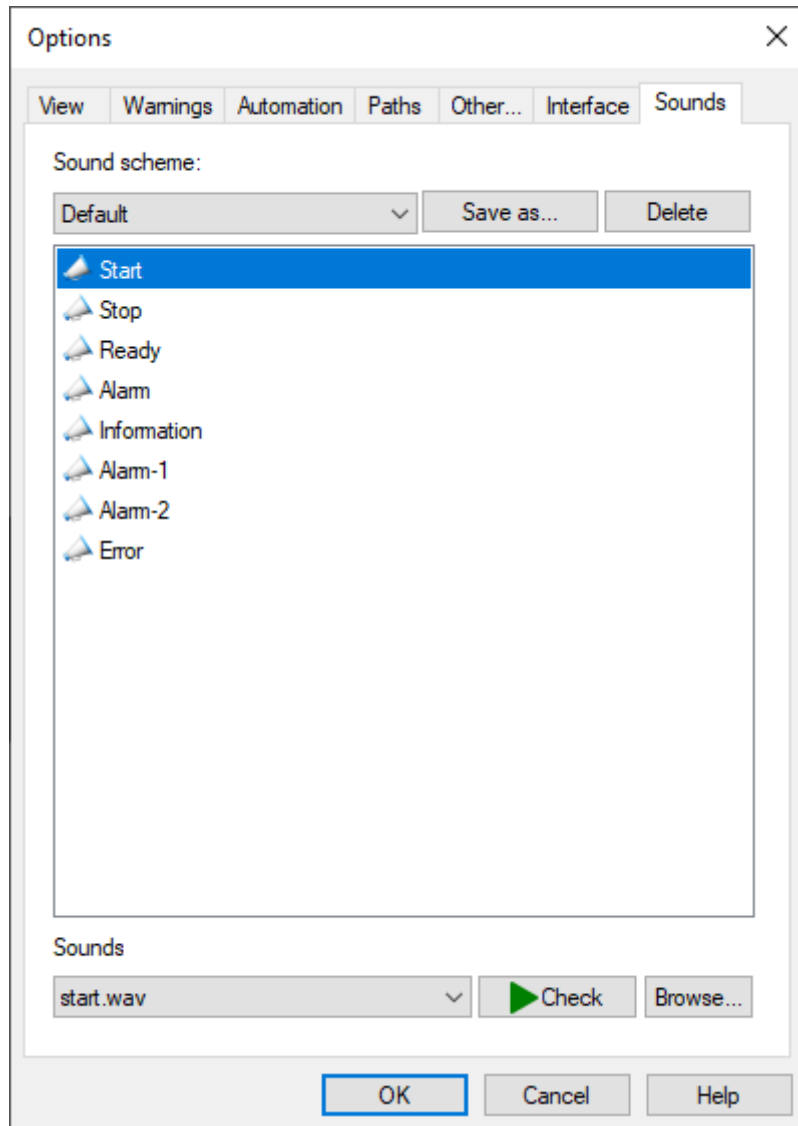

Fig. 13: Options > Sounds

5.4. User Options

Chromos SW has two types of profiles: guest profile and user profile. You can configure user parameters (access level) (Fig. 14).

You can select a default enter type: a password, a key, or a fingerprint. For the user profile, you can select access level privileges. There are the following privileges:

- Device Plug&Play — allows to configure the module connection with the instrument bus (to enable it, you need to enter a password).
- Edit the method — allows to edit the analysis method.
- Edit program settings — allows to change the general software settings.
- Device calibration — allows to calibrate the instrument (to enable it, you need to enter a password).

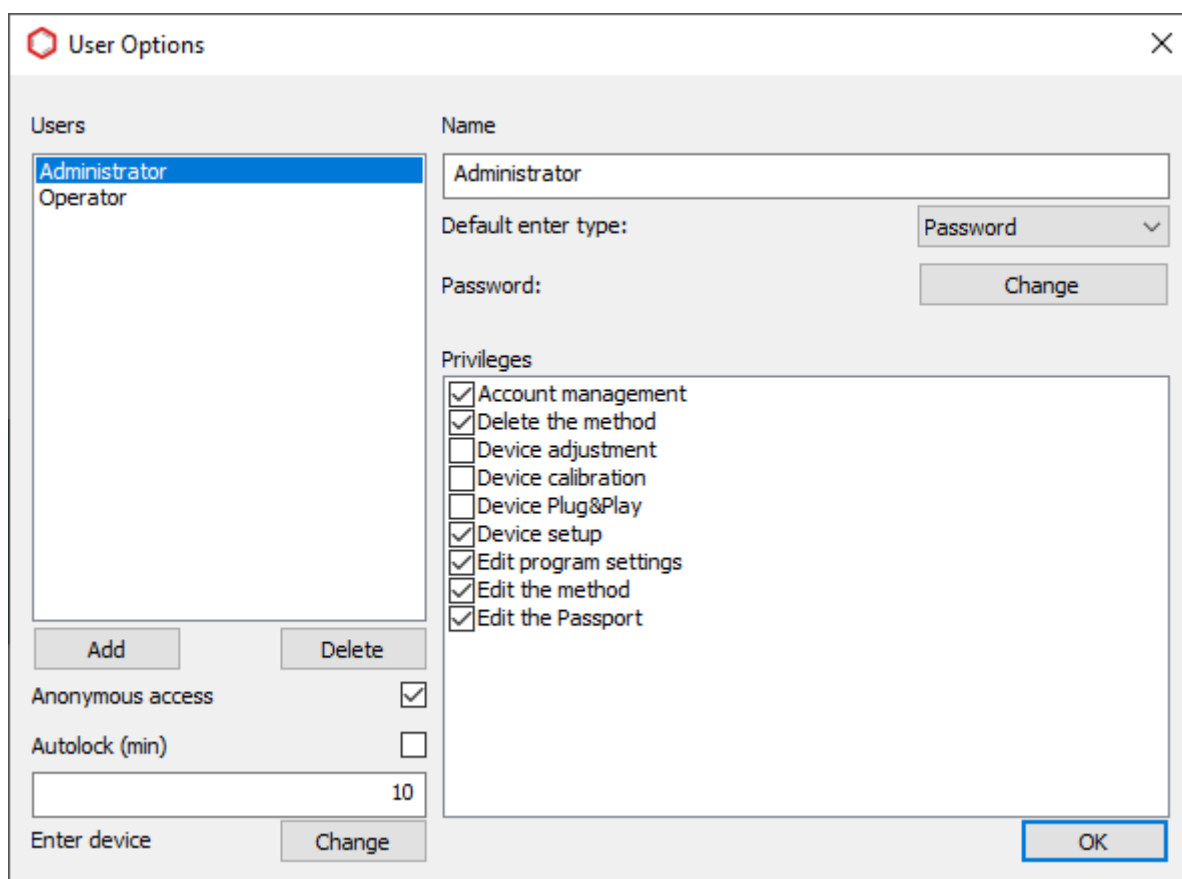

Fig. 14: User Parameters

- Device adjustment – allows to adjust the instrument (to enable it, you need to enter a password).
- Device setup – allows to configure the software for the instrument.
- Edit the Passport – allows to edit the chromatogram passport.
- Delete the method – allows to delete the analysis method.
- Account management – allows to manage user accounts.

The following privileges are active by default for the guest profile:

- Account management
- Delete the method
- Edit the Passport
- Edit program settings
- Edit the method
- Device setup

The user can log into the software via a guest profile or a user profile. Anonymous access is enabled to set up a guest profile. For a user profile, auto lock can be configured – if no action is taken within specified time, the profile is logged out. You need to enter a password to log in again.

For more details on how to manage the user parameters, see [Sec. 6.2. Managing the User Parameters](#).

5.5. Operation Log

The Chromos SW workflow is recorded into the operation log. This information is used to identify the causes of instrument failure or incorrect operator actions. In case of a breakdown, the instrument diagnostics shall be carried out by the manufacturer.

The program log collects the following information:

- Data transmitted to the instrument (parameters are described in the Report protocol).
- Current temperatures, gas flow rates, heating values, etc. — once every 30 seconds in the instrument recording preparation mode.
- Program startup and shutdown time.
- Time of data loading from the method to the instrument.
- Time of method change (writing).
- Analysis start and stop times.

All information recorded in the log has a date and time. Auto update is enabled by default for the log.

The Operation Log can be saved and sent via the Internet. For more details on how to use the log, see [Sec. 9.3. Debugging Using the Operation Log](#).

6. Chromos Software Operating Instructions

6.1. Registering the Software

When you first boot after installing Chromos SW on your computer, you see a registration warning (Fig. 15):

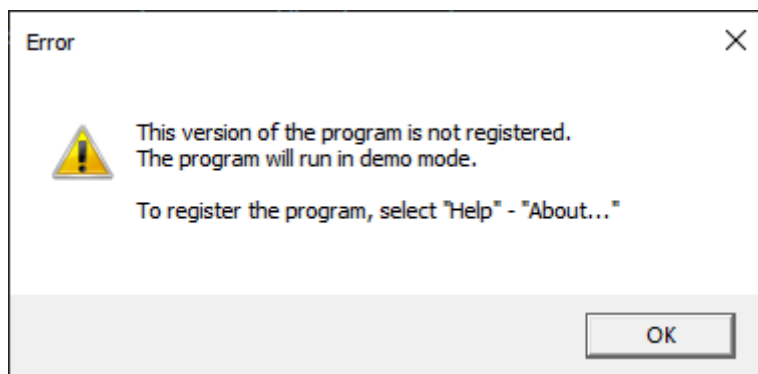

Fig. 15: Registration Warning

To register the program, do the following:

1. In the *Help* menu, select **About...** The *About...* window opens (Fig. 16).

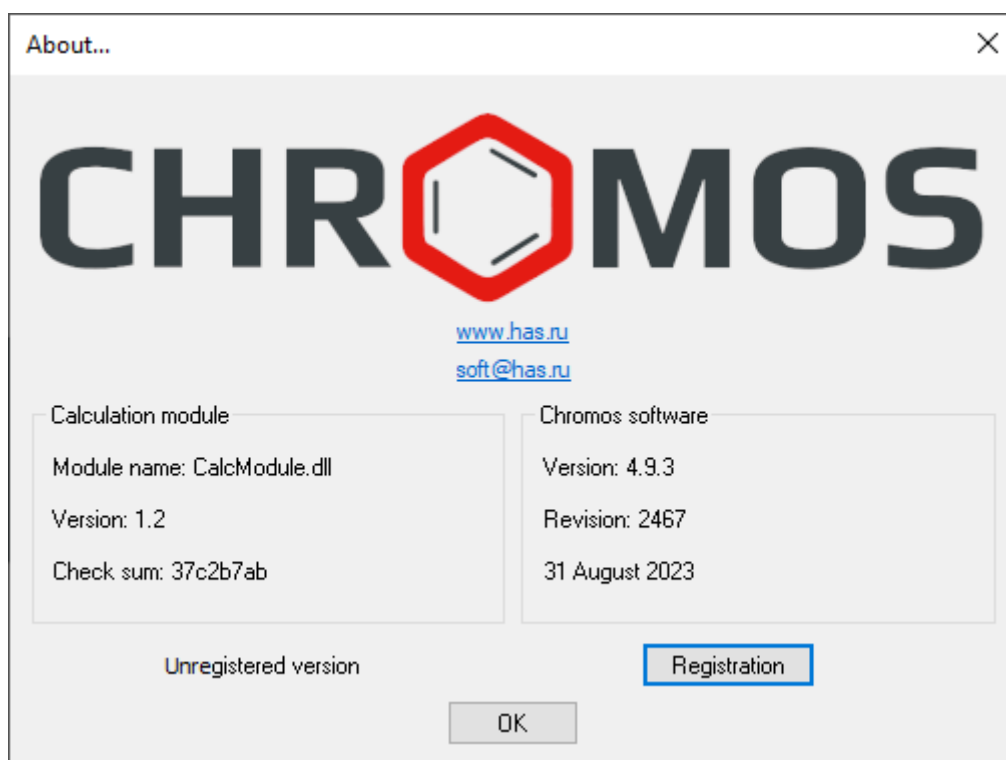

Fig. 16: About...

2. In the *About...* window, click **Registration**.
3. Enter the serial number indicated on the software drive.
4. Click **OK**.

6.2. Managing the User Parameters

In Chromos SW, you can manage user (access level) parameters.

To configure the user parameters, do the following:

1. In the *Chromatogram* menu, select **Accounts > Control**. The *User Options* window opens.
2. Select an existing access level from the list or click **Add** and create a new one.
3. In the *Name* field, enter the user name.
4. In the *Default enter type* field, select the enter type from the list:
 - Password
 - Key
 - Fingerprint
5. To configure the enter type, click **Change**. The dialog settings window opens.

Note: The parameters depend on the type selected.

- For a password:
 - To set the password manually, select **Enter Password Manually**, then in the *New Password* and *Confirmation* fields, enter the password.
 - To create a password automatically, select **Generate a random password** and click **Create**.
 - Click **OK**.
- For a key:
 - Connect the key. The serial number appears in the *User key* field.
 - To disable the key request, select the **Do not ask for a key** checkbox.
 - Click **OK**.
- For a fingerprint:
 - Place your fingerprint on the scanner.
 - Click **OK**.

-
1. To configure the password, click **Change**. The *Change User Password* window opens.
 - To set the password manually, select **Enter Password Manually**, then in the *New Password* and *Confirmation* fields, enter the password.
 - To create a password automatically, select **Generate a random password** and click **Create**.
 - Click **OK**.
 1. Select checkboxes for the desired privileges (see [Sec. 5.4. User Options](#)).
 2. To enable anonymous (guest) access, select the **Anonymous Access** checkbox.
 3. To configure the auto lock, select the **Autolock** checkbox and enter the time (in minutes) after which the profile will be logged out if no action is taken.
 4. (Optional) To delete a user, select the user from the list and click **Delete**.
 5. Click **OK**.

6.3. Managing the External Tools

In Chromos SW, you can add shortcuts to external applications, such as chromatogram export and import utilities.

To configure external tools shortcuts, do the following:

1. In the *Data* menu, select **External Tools**. The *External Tools* window opens.
2. Select the action:
 - To add a shortcut, click **Add**;
 - To delete the selected shortcut, click **Delete**;
 - To move the shortcut in the menu, click **Move Up** or **Move Down** correspondingly.
3. In the *Title* field, enter the name of the shortcut.
4. In the *Executable file* field, enter the path to the executable file.
5. Click **OK**.

The added shortcut is now displayed in the *Data* menu.

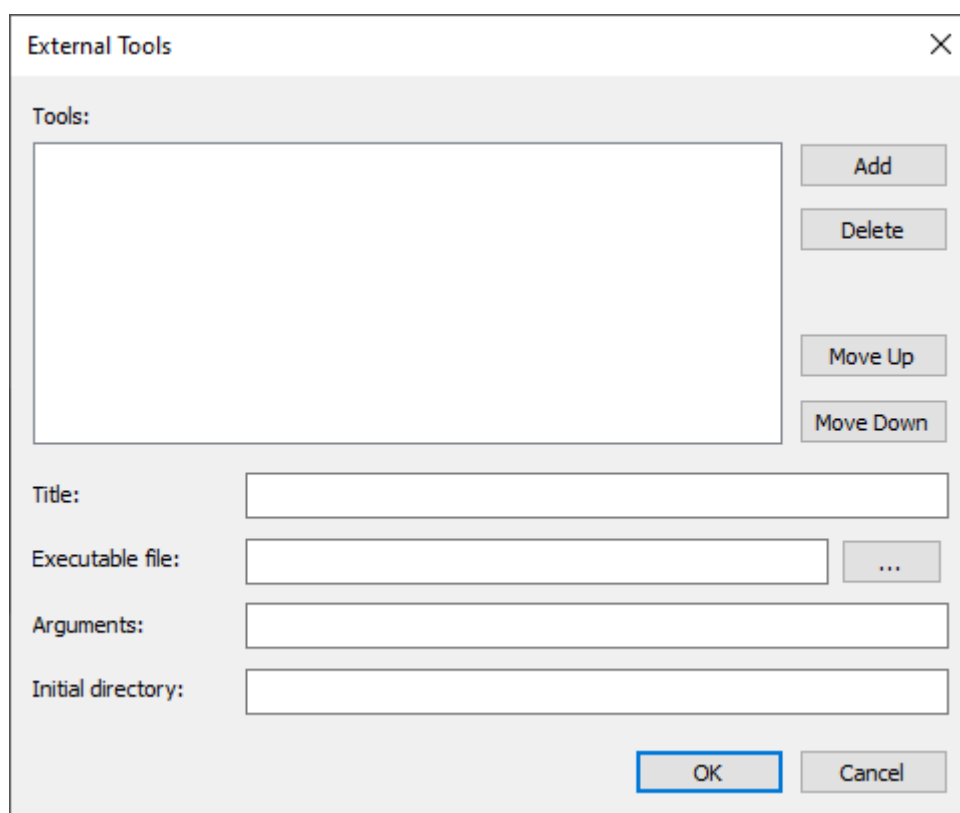

Fig. 17: External Tools

6.4. Connecting the Device

In Chromos SW, you can plug the following compatible devices:

- «Chromos GC-1000», «Chromos LC-301» (using EChD+CD, CD+ADC, or ADC-2M), and «Tsvet-500» (using MRM-10) chromatographs;
- «Chromos LAS-23», «Chromos HSS-A», «Chromos HSS-A2», HT1500L, and HT3100A samplers;
- «Chromos Cryo» system, «Valco» valve, «SPF-05», «Fluorat» devices.

In the unregistered program version, there is only a Demo-ADC connection. If the software is registered, you can connect the instrument to your computer.

1. Connect the *Computer* connector on the instrument to any free COM-port on your computer with a special cable from the supply package.
2. In the *Devices* menu, select **Connection...** The *Device Connection* window opens (Fig. 18):

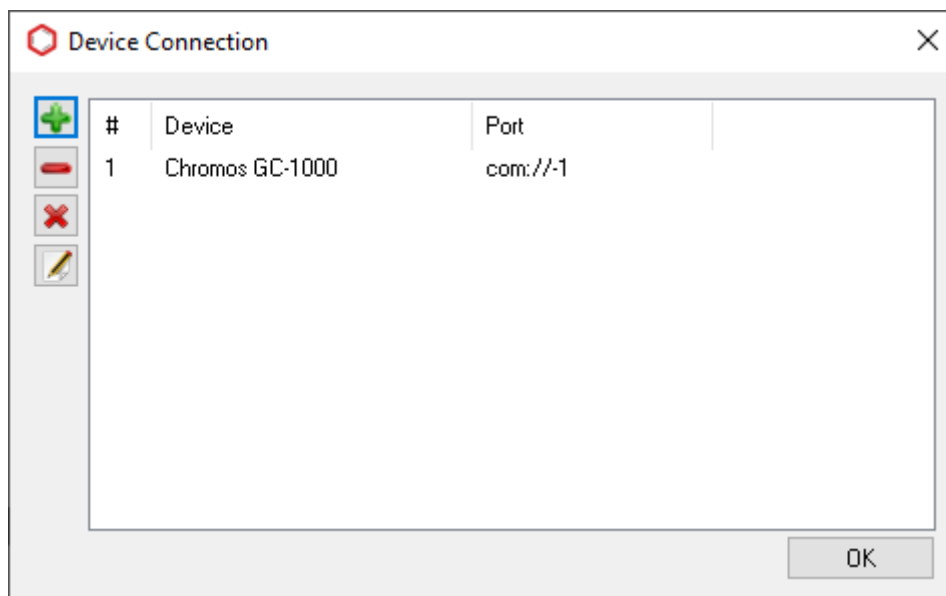

Fig. 18: Device Connection

1. To add a device, click  **Add**. The *Add New Device* window opens (Fig. 19):

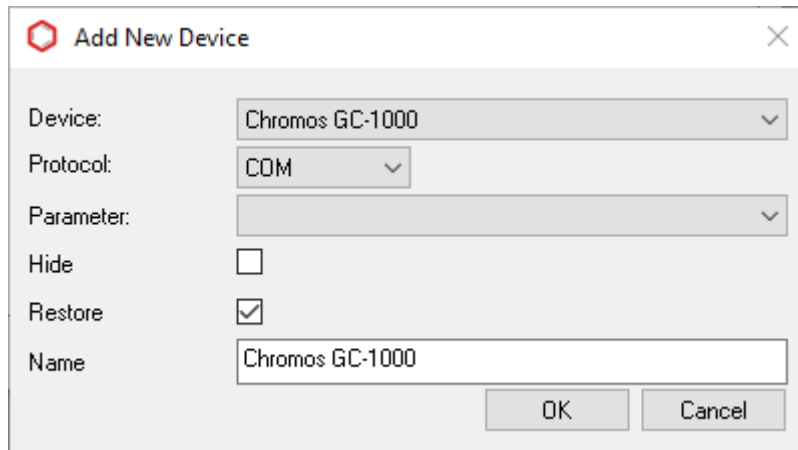

Fig. 19: Add New Device

2. In the *Device* field, select a device from the list.
3. In the *Protocol* field, select from the list the interface via which the instrument is connected. The compatible connection method (COM/TCP) depends on the device.
4. In the *Parameter* field, select a COM-port (if a COM-interface is selected) or specify a connection parameter (if a TCP is selected).
5. To avoid displaying the device on the control panel, select the **Hide** check box.
6. To restore the device connection parameters, select the **Restore** check box. This option is enabled by default.
7. In the *Name* field, enter the device name.
8. Click **OK**.



After the device is added, it is displayed on the control panel.

6.5. Launching the Instrument

When the instrument is switched on for the first time, you need to configure its operating mode to be used later in the method file. To do this, create a method, select the instrument settings, and then record them in the method file.

Note: For more details on how to create a new method, see [Sec. 6.9. Creating an Analysis Method](#).

To configure the instrument, do the following:

1. Connect the eluent to the instrument.
2. Start up Chromos SW.
3. Switch on the instrument.
4. Connect the instrument to Chromos SW, click  **Connect**. If the connection is successful, the channel checkboxes  will light up red.
5. On the control panel, next to the instrument name, click  **Operating Mode**.
6. Set the desired values for the instrument. For a detailed description of this step, see [Sec. 6.7. Configuring the Instrument](#).
7. In the *Configuration* window, click -> **to Method**. The *Select Method* window opens.
8. In the *Select Method* window, choose the created method to be used with the instrument and click **OK**.

6.6. Device Configuration

The device settings are selected in the *Configuration* window, which varies depending on a chromatograph, sampler, detector, etc. This Manual gives an overview of chromatograph settings (based on the «Chromos GC-1000» configuration). For more details on how to operate specific devices, see [Sec. 7. Specific Devices Operating Procedures](#).

You can open the *Configuration* window either from the *Devices* menu (*Devices* > <*Connected Device*> > *Settings...*) or from the control panel ( **Operating Mode** next to the device name).

For more details on how to configure the instrument, see [Sec. 6.7. Configuring the Instrument](#). For more details on adjustment, see [Sec. 6.8. Adjusting the Instrument](#).

6.6.1. Chromatograph Configuration

The *Configuration* window for a chromatograph may contain the following tabs:

- General;
- Additional;
- Control;
- Valves and Thermostats;
- Switching Valves;
- Adjustment;
- Errors.

Below are descriptions of each of these tabs.

6.6.1.1 General

In the *General* tab (Fig. 20) you can set temperature of temperature-controlled objects, adjust the temperature program of columns and specify operating parameters for gas flow regulators. This tab also displays information about the instrument readiness for analysis.

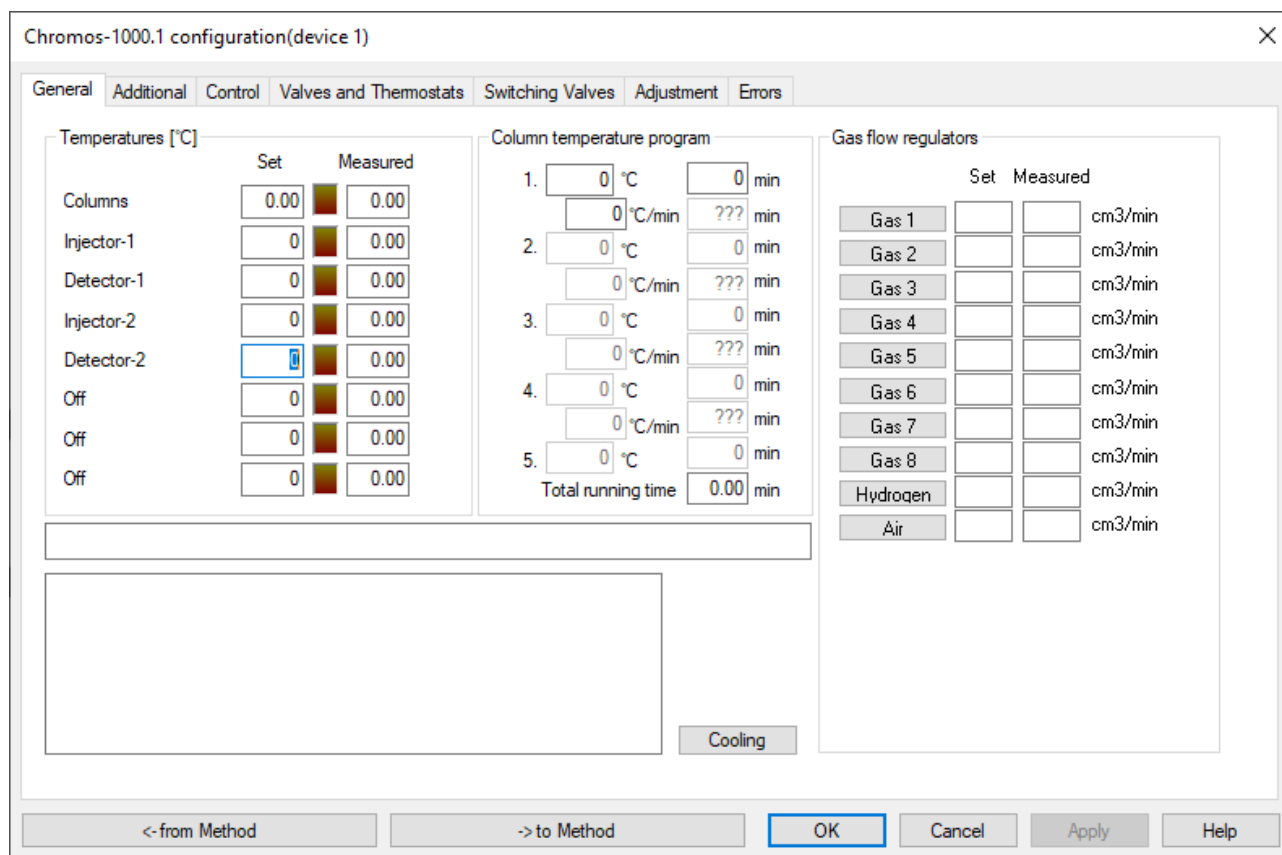

Fig. 20: Chromos GC-1000.1 Configuration > General

6.6.1.2 Additional

The *Additional* tab (Fig. 21) contains a list of connected detector modules, overheat control values, permissible deviations and ignition parameters. In the *Additional* tab, you can set temperature tolerances of temperature-controlled objects, gas flowrate tolerances, flame ignition parameters of FID, FTD, FPD, as well as buttons to start recording on additional channels.

For more details on additional recording channels, see [Sec. 8.5. Additional Recording Channels](#).

6.6.1.3 Control

The *Control* tab (Fig. 22) is used to monitor the following parameters:

- Status of gas flow regulator (GFR): measured flow rate, instrument inlet pressure (P_{in}), pressure upstream of column (P_{out}), voltage at GFR valve (V_{valve});
- Detector response;
- Oven exhaust vent position;
- Mains voltage;
- Presence of flame in detectors (FID/FTD).

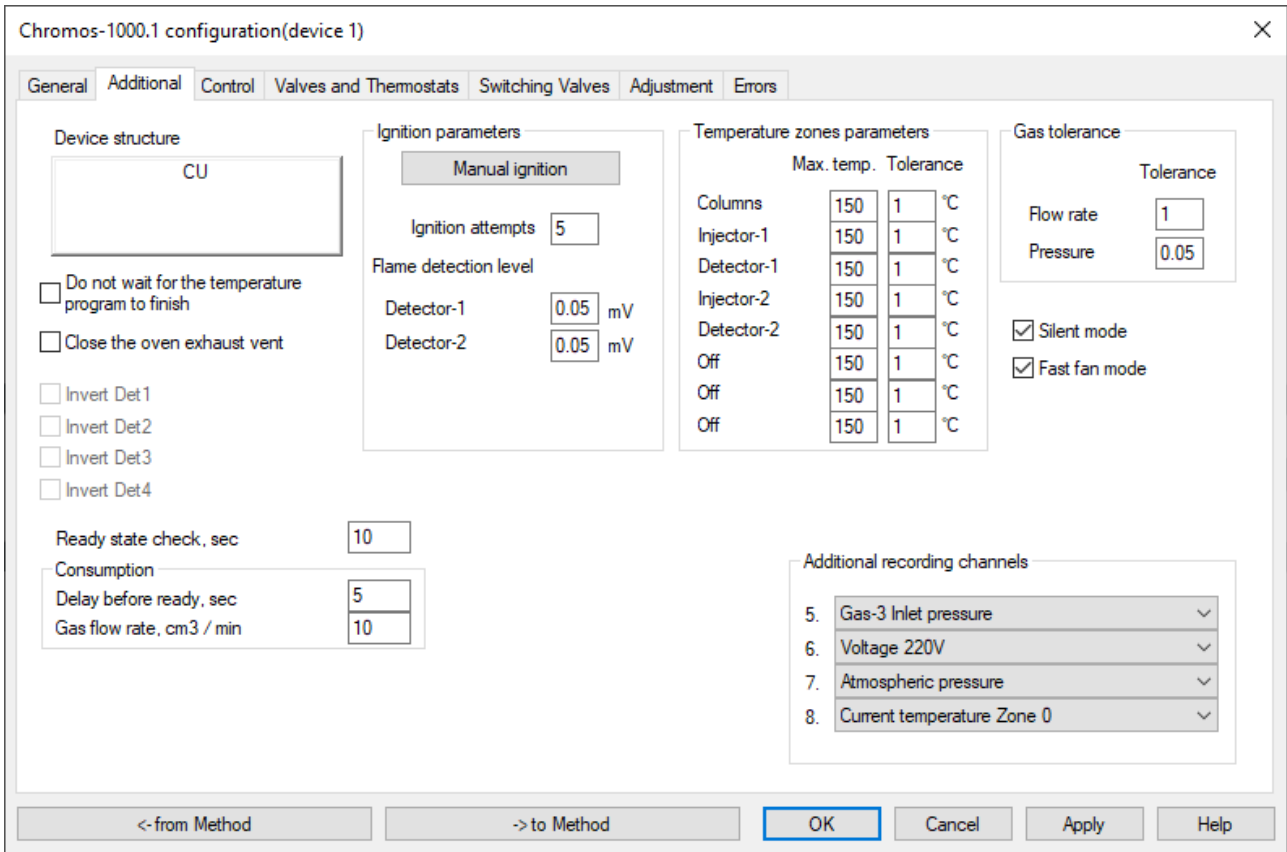

Fig. 21: Chromos GC-1000.1 Configuration > Additional

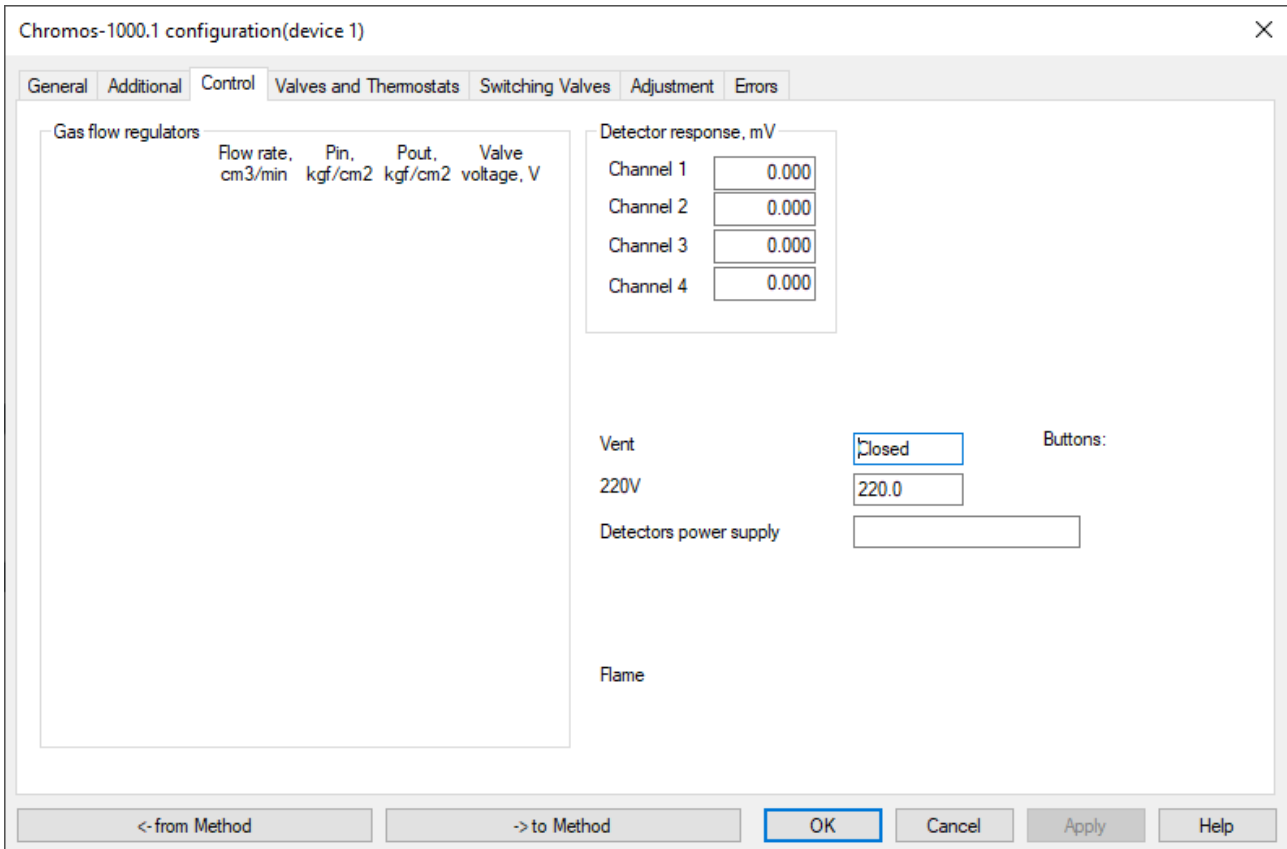

Fig. 22: Chromos GC-1000.1 Configuration > Control

6.6.1.4 Valves and Thermostats

In the *Valves and Thermostats* tab (Fig. 23), you can configure injection valves and switching valves with automatic electric drive, if the instrument has any.

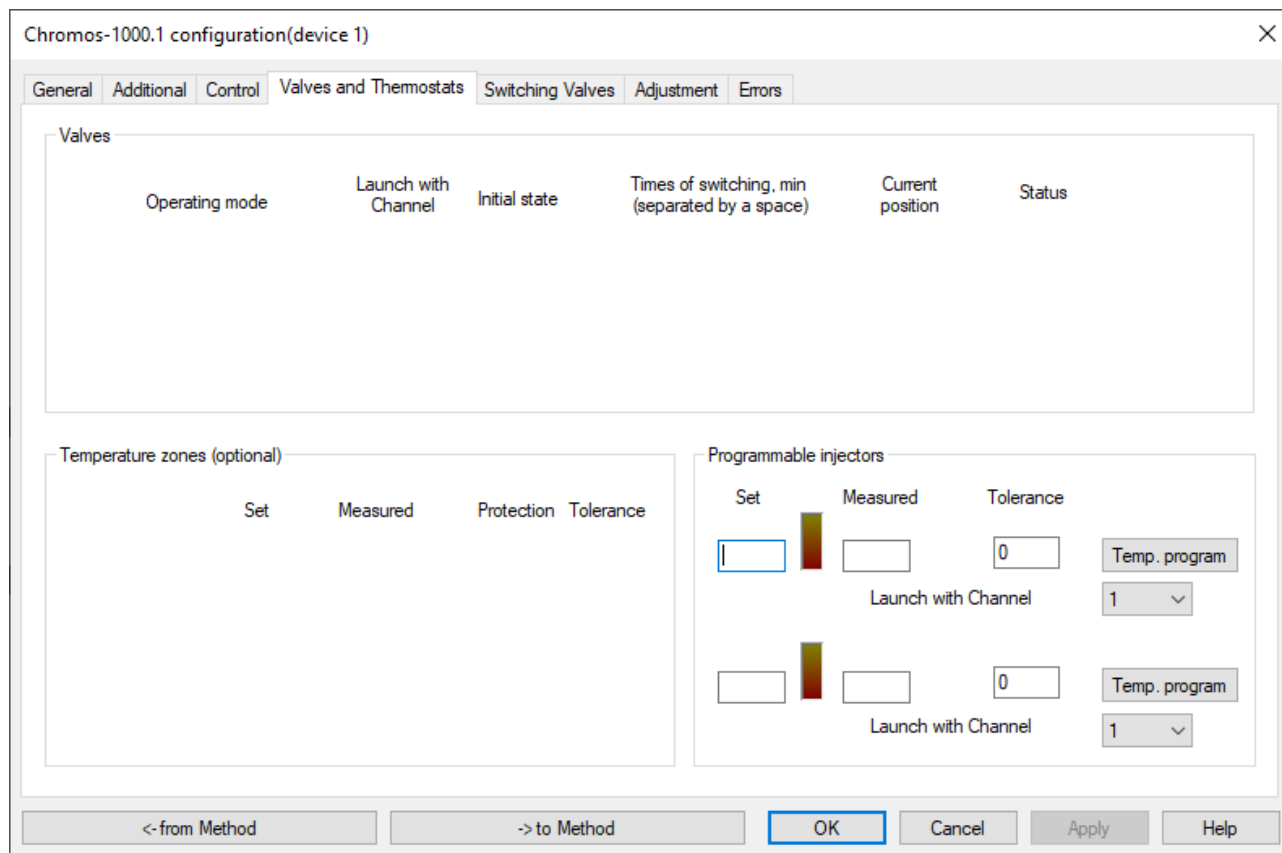

Fig. 23: Chromos GC-1000.1 Configuration > Valves and Thermostats

6.6.1.5 Switching Valves

In the *Switching Valves* tab (Fig. 24), you can configure the starting position and switching times of valves during analysis.

6.6.1.6 Adjustment

In the *Adjustment* tab (Fig. 25), you can configure PID coefficients of temperature zones and all modules in the chromatograph.

6.6.1.7 Errors

The *Errors* tab (Fig. 26) displays reports on errors that occur during instrument operation.

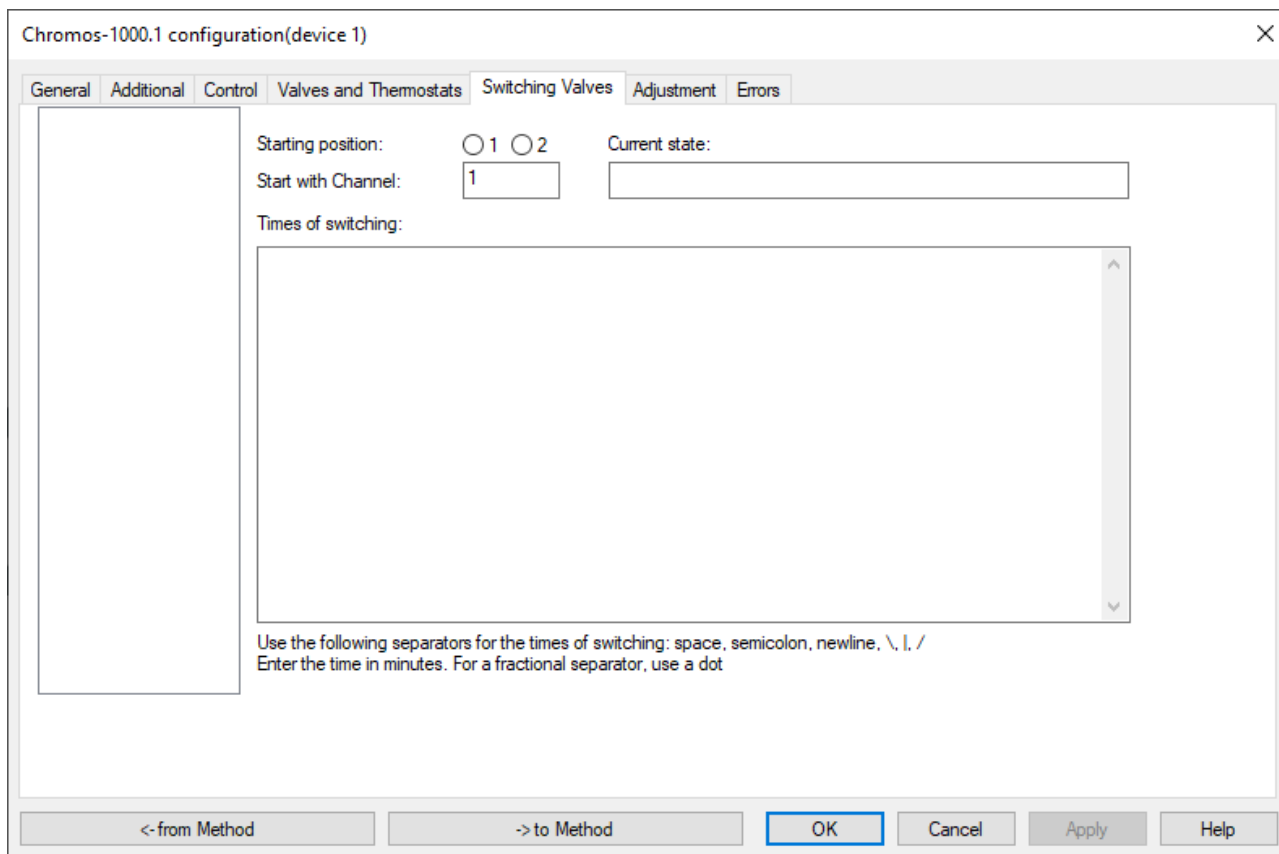

Fig. 24: Chromos GC-1000.1 Configuration > Switching Valves

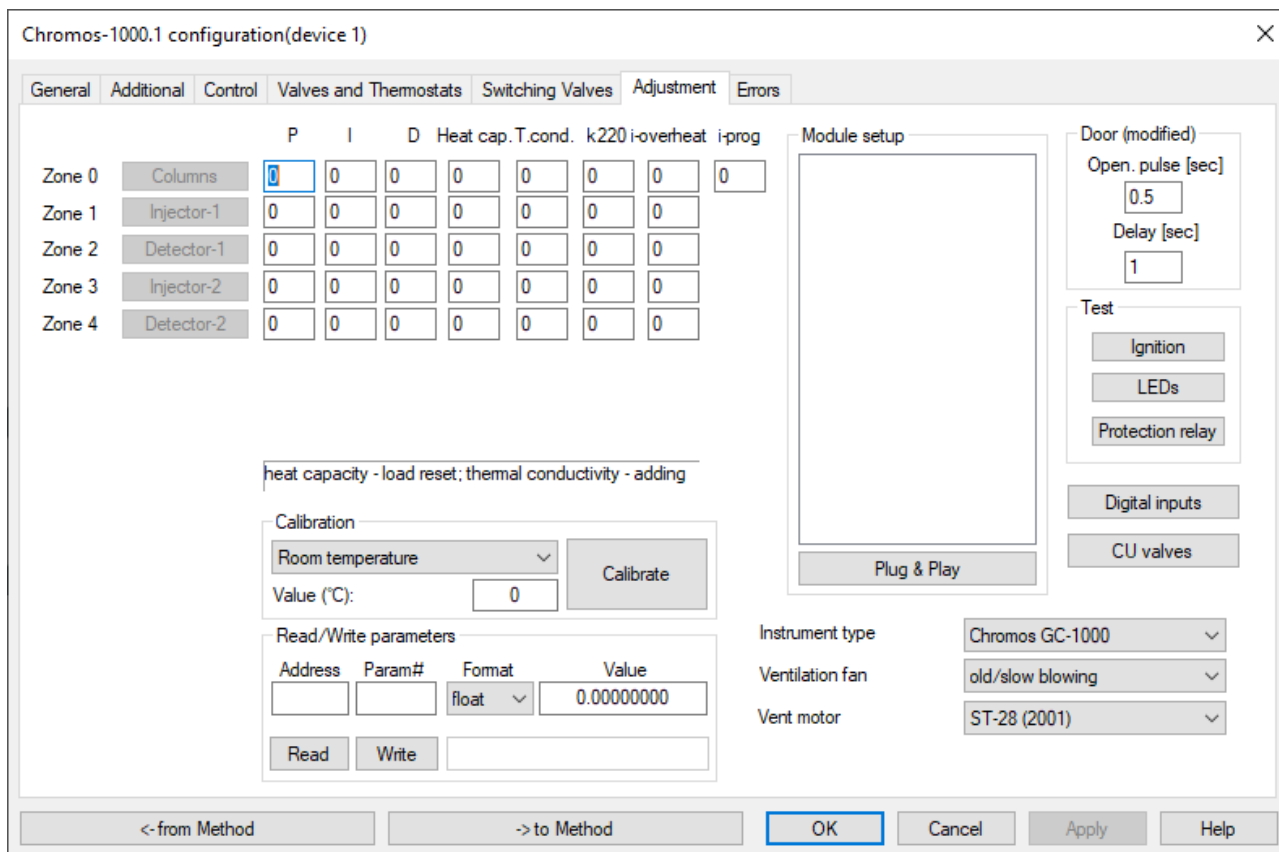

Fig. 25: Chromos GC-1000.1 Configuration > Adjustment

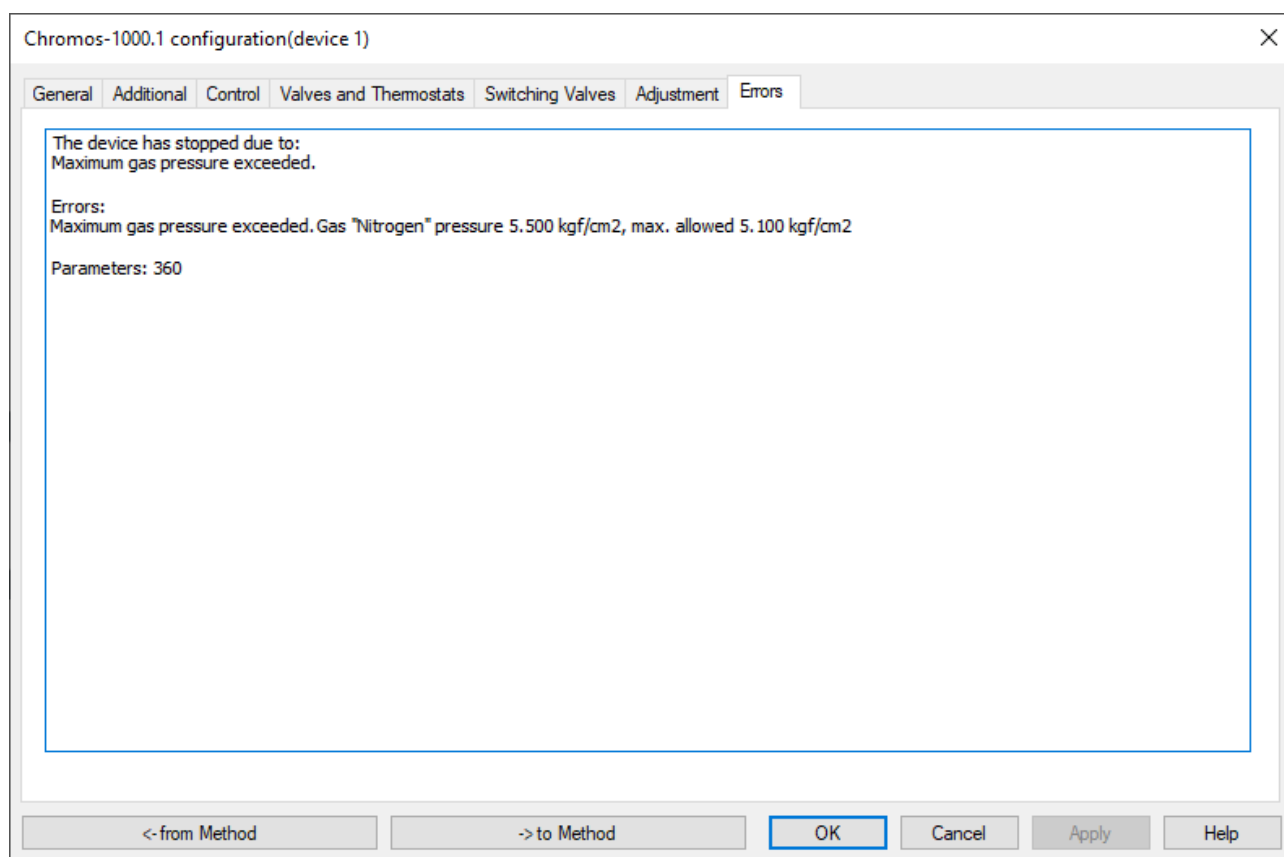

Fig. 26: Chromos GC-1000.1 Configuration > Errors

6.6.2. Other Devices Settings

The settings window of other instruments varies depending on the connected instrument. For more details, see [Sec. 7. Specific Devices Operating Procedures](#).

6.7. Configuring the Instrument

When an instrument is connected and configured, you need to set its parameters. The parameters are set in the *Configuration* window described in [Sec. 6.6. Device Configuration](#). Below are steps to configure the basic parameters. For more details on how to configure certain instruments, see [Sec. 7. Specific Devices Operating Procedures](#).

6.7.1. Setting the Chromatograph Parameters

1. In the *General* tab, in the *Set* fields of the *Temperatures (°C)* section ([Fig. 27](#)), enter a temperature value for each temperature zone. The measured temperatures are displayed in the *Measured* fields.



Temperatures [°C]		Set	Measured
Columns	<input type="text" value="0.00"/>		<input type="text" value="0.00"/>
Injector-1	<input type="text" value="0"/>		<input type="text" value="0.00"/>
ECD-1	<input type="text" value="0"/>		<input type="text" value="0.00"/>

Fig. 27: Temperature Parameters

- In the *Column temperature program* section (Fig. 28), specify data on the column oven temperature program (fields are to be filled for each stage):
 - In the °C field, enter initial temperature of the stage (in °C).
 - In the *min* field, enter stage duration (in min).
 - In the °C/min field, enter the rate of temperature increase to the next stage level (in °C/min).

Note: If the temperature increase rate is set to zero, the cycle is near completion and the last temperature is maintained until the end of analysis.

Column temperature program

1.	0 °C	0 min
	0 °C/min	??? min
2.	0 °C	0 min
	0 °C/min	??? min
3.	0 °C	0 min
	0 °C/min	??? min
4.	0 °C	0 min
	0 °C/min	??? min
5.	0 °C	0 min
Total running time		0.00 min

Fig. 28: Temperature Program Parameters

- In the *Gas flow regulators* section (Fig. 29), specify data on the flow rates and types of carrier gas, as well as hydrogen and air:
 - To select the type of carrier gas or to program the modes of gas flow regulators (GFRs), select the channel (in the figure below: 1. Nitrogen). For details on how to configure GFR modes, see [Sec. 6.7.4. Configuring Gas Flow Regulators \(GFRs\)](#).
 - In the *Set* fields, enter the flow rate (in cm³/min) or another value programmed in the mode. The measured value is displayed in the *Measured* fields.

Gas flow regulators

	Set	Measured	
1. Nitrogen	0	0.0	cm3/min
2. Nitrogen	10	0.0	cm3/min
3. Nitrogen	0	0.0	cm3/min
4. Nitrogen	20	0.0	cm3/min

Fig. 29: Carrier Gas Parameters

- In the *Additional* tab, in the *Ignition parameters* section (Fig. 30), specify the ignition parameters:
 - In the *Flame detection level* field, enter the flame detection level of detectors (in mV, see [Sec. 8.8.22. Flame Detection Level](#)).
 - In the *Ignition attempts* field, enter the number of attempts.

Ignition parameters

Manual ignition

Ignition attempts

Flame detection level

Detector-1 mV

Detector-2 mV

Fig. 30: Ignition Parameters

- To control the ignition manually, click **Manual ignition**.
- In the *Temperature zone parameters* section (Fig. 31), specify data on temperature-controlled objects:
 - In the *Max. temp.* field, enter the maximum permitted temperature for the object used (in °C).
 - In the *Tolerance* field, enter permissible deviations of measured temperatures from setpoints (in °C).

Temperature zones parameters

	Max. temp.	Tolerance	
Columns	<input type="text" value="150"/>	<input type="text" value="1"/>	°C
Injector-1	<input type="text" value="150"/>	<input type="text" value="1"/>	°C
Detector-1	<input type="text" value="150"/>	<input type="text" value="1"/>	°C
Injector-2	<input type="text" value="150"/>	<input type="text" value="1"/>	°C
Detector-2	<input type="text" value="150"/>	<input type="text" value="1"/>	°C

Fig. 31: Temperature Zone Parameters

- In the *Gas tolerance* section (Fig. 32), indicate permissible deviations of measured values from setpoints for the gases used.
 - In the *Flow rate* field, enter the permissible flow rate deviation.
 - In the *Pressure* field, enter the permissible pressure deviation.

Gas tolerance

Tolerance

Flow rate

Pressure

Fig. 32: Gas Tolerance Parameters

- (Optional) Set the operating mode of a laboratory chromatograph cooling fan:
 - To start it in silent mode, select the **Silent mode** checkbox.
 - To run it at full power, select the **Fast fan mode** checkbox.
- In the *Valves and Thermostats* tab, in the *Valves* section (Fig. 33), indicate valve settings, if the valve is part of the instrument:
 - In the *Operating Mode* list, select the type of valve.
 - In the *Launch with channel* list, select the channel button that starts the chromatogram recording simultaneously with the valve operation.

- (For switching valves) In the *Initial state* list, select the initial valve position at the time the chromatogram is recorded.
- (For switching valves) In *Time 1* and *Time 2* fields, enter the time (in minutes) after which the valve will switch to position 1 or 2, respectively.

Valves							
	Operating mode	Launch with Channel	Initial state	Times of switching, min (separated by a space)		Current position	Status
1.	Inj. valve	Chan. 1	1	800	800	Analysis	625
2.	Inj. valve	Chan. 1	1	800	800	Analysis	929

Fig. 33: Valve Parameters

1. To save the settings, click **OK** or **Apply**.

6.7.2. Configuring Sampler Parameters

1. To set the injection parameters, navigate to *Configuration > Settings > Dosing* and do the following:
 - In the *Dose volume* field, enter the dose volume (in μL).
 - In the *Number of injections in series* field, enter the number of injections.
 - In the *Sample loading rate* field, enter the sample loading rate (in $\mu\text{L/s}$).
 - In the *Sample injection rate* field, enter the sample injection rate (in $\mu\text{L/s}$).
 - In the *Time inside the injector before dosing* field, enter the time the sample stays in the injector before its injection (in seconds).
 - In the *Time inside the injector after dosing* field, enter the time the sample stays in the injector after its injection (in seconds).
1. To set the analysis parameters, navigate to *Configuration > Settings > Analysis* and do the following:
 - In the *Instrument* field, select the instrument to be used in the analysis from the list of connected instruments.
 - In the *Select the injector for dosing* field, select a injector from the list:
 - Near;
 - Distant;
 - Both;
 - Both (High Prod.)
 - If you use the near injector, in the *Launch channels for the near injector* field, check the boxes for the channels to be started for the near injector.
 - If you use the distant injector, in the *Launch channels for the distant injector* field, check the boxes for the channels to be started for the distant injector.
1. To set washing parameters, navigate to *Configuration > Additional Settings > Washing during injection* and do the following:
 - In the *Washing times* field, select the number of washes (0–15) from the list.
 - In the *Before dosing* field, select the washing solution from the list and enter the injection volume (in μL).
 - In the *Washing with the sample* field, enter the sample volume injected for washing (in μL).

- In the *After dosing* field, select the washing solution from the list and enter the injection volume (in μL).
 - In the *Washing mode* field, select the washing mode from the list:
 - Before each loading
 - Before each new sample
1. To set the debubbling parameters, navigate to *Configuration > Additional Settings > Bubble elimination* and do the following:
 - In the *Pumping times* field, select the number of pumping times (0–15) from the list.
 - In the *Delay between pumping* field, select the delay value (0–15).
 1. To set the manual washing parameters, navigate to *Configuration > Additional Settings > Manual washing* and do the following:
 - In the *Solution* field, select the washing solution from the list and enter the injection volume (in μL).
 - In the *Washing times* field, select the number of washes (0–15) from the list.
 1. To set the parameters for using the internal standard, navigate to *Configuration > Additional Settings > Internal standard* and do the following:
 - To use an internal standard, check the **Use internal standard** box.
 - In the *Tube for internal standard* field, select a tube (vial) from the list.
 - In the *Internal standard volume* field, enter the volume ((in μL).
 1. To save the settings, click **Apply**.
 2. In the *General* tab, select the required action:
 - To start injection, click **Start**.
 - To stop injection, click **Stop**.
 - To start washing, click **Wash**.

6.7.3. Gas Flow Regulators (GFRs)

Gas flows in the «Chromos GC-1000» chromatograph are controlled by universal electronic gas flow regulators (GFRs).

There are inlet and internal GFRs. The inlet GFRs are connected to feed gases (carrier gas, hydrogen, air). The internal GFRs are used inside the chromatograph gas circuit (sample discharge, septum blow-off).

For the inlet GFRs, the manufacturing plant enables the gas presence control mode in the line of primary regulators. For the internal GFRs, such control is disabled.

The GFR status can be set by selecting the GFR channel in the *Configuration* window (see [Sec. 6.7.4. Configuring Gas Flow Regulators \(GFRs\)](#)). The symbol & in the *Destination* field means that gas presence control for this GFR is disabled. If there is no such a symbol, the control is enabled.

Inlet gas pressure control can only be disabled by a user with the *Device adjustment* privilege.

For more details on GFR adjustment, see [Sec. 6.7.4. Configuring Gas Flow Regulators \(GFRs\)](#).

6.7.4. Configuring Gas Flow Regulators (GFRs)

To configure GFR parameters:

1. On the control panel next to the instrument name, click  **Operating Mode**. The *Configuration* window opens (Fig. 34).

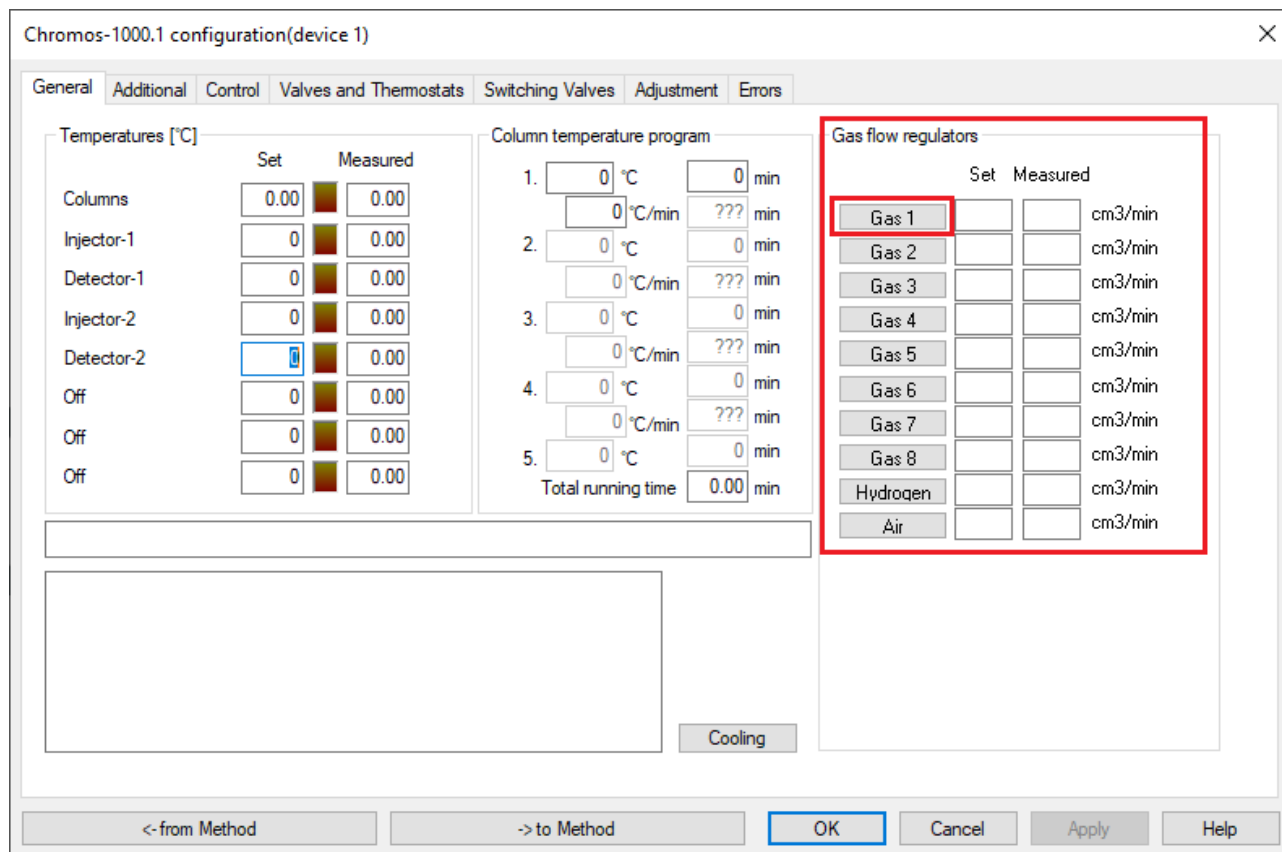

Fig. 34: Configuration

1. Navigate to *Configuration* > *General*.
2. Select the GFR channel you want to configure (in the example: 1. Helium). The *GFR Configuration* window opens (Fig. 35).

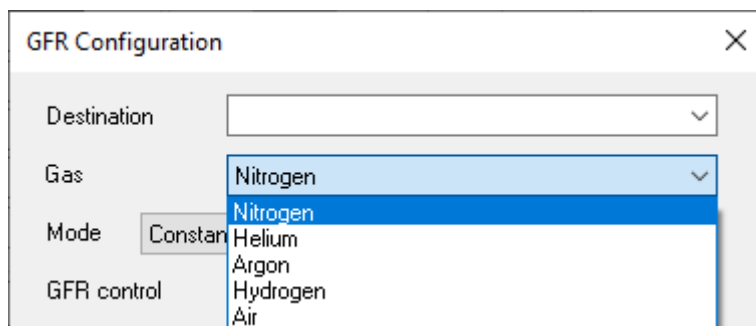

Fig. 35: GFR Configuration

1. In the *Destination* field, select an option from the list or enter a value manually.
2. In the *Gas* field, select the gas flow controlled by the configured GFR.

Note: Filling in the *Gas* field is mandatory!

1. In the *Mode* field, select the GFR operating mode.

Note: Detailed description of modes is given in [Sec. 8.8. Gas Flow Regulator Operating Modes](#).

2. Click **Close**.
3. Click **Apply**.

6.7.5. Inlet Pressure Control

Chromos SW monitors the inlet pressures supplied to the gas flow regulators (GFRs). When the maximum permissible pressure is exceeded (depending on the GFR modification and model, in the basic version it is 5.1 kgf/cm²), the software switches the instrument to alarm mode. It is evidenced by a red indicator *Error* on the chromatograph front panel. At the same time, the program issues an information message about the error ([Fig. 36](#)):

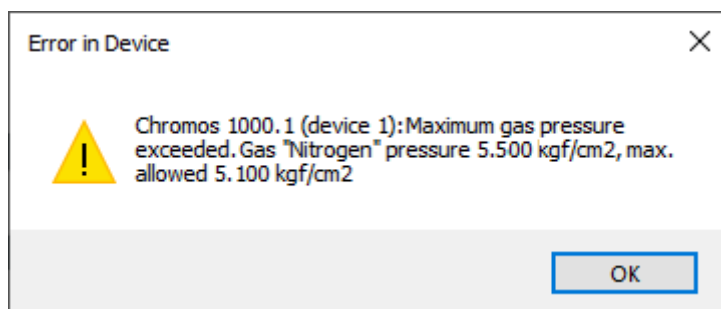

Fig. 36: Error: Inlet Pressure Exceeded

For more details on how to handle errors and restart the instrument, see [Sec. 9.1. Restarting the Device in Case of Error](#).

Chromos SW also allows to detect the absence of carrier gas. If pressure at the inlet GFR is below 0.5 kgf/cm², the instrument switches to the *Waiting for Gas Supply* mode. In this case, the bridge of a thermal conductivity detector (TCD) or catalytic combustion detector (CCD) is de-energized and column heating is turned off.

For more details on disabling the inlet gas control, see [Sec. 6.7.6. Disabling the Inlet Pressure Control](#).

6.7.6. Disabling the Inlet Pressure Control

You can disable the inlet gas pressure control at the GFRs.

1. On the control panel next to the device name, click  **Configuration**. The *Configuration* window opens.
 2. In the *Configuration* window, navigate to the *Gas flow regulators* section and select the GFR. The *GRF Configuration* window opens. ([Fig. 37](#)).
1. Select the **GFR Control** checkbox.
 2. Click **Close**.
 3. Click **Apply**.

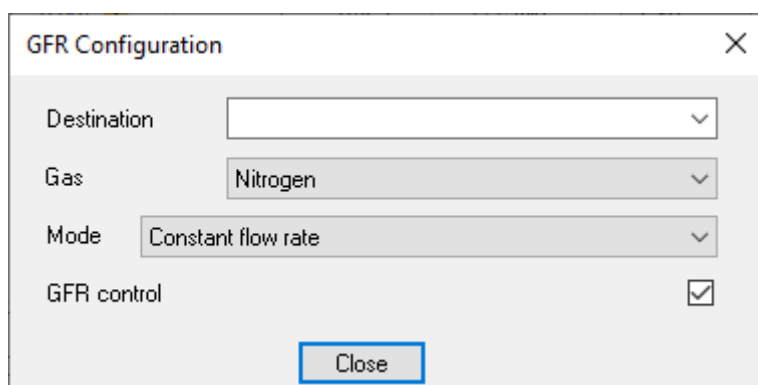

Fig. 37: GFR Configuration > GFR Control

6.8. Adjusting the Instrument

The instrument adjustment includes the proportional-integral-differential (PID) control of temperature zones and the configuration of chromatograph modules. To adjust the instrument, navigate to *Configuration > Adjustment* (Fig. 38). This operation can only be performed by users with the *Device adjustment* and *Device calibration* privileges and is password protected.

The instrument adjustment includes setting the PID coefficients for temperature zones, as well as coefficients of heat capacity, thermal conductivity, 220 V voltage fluctuations, and overheat control. Tables with relevant coefficients are given in separate documents for setup personnel (for example, “PGC PID Coefficients”). The chromatograph modules are configured in dialog boxes of relevant boards selected from the list in the *Module setup* field.

The adjustment process is detailed in documentation for setup personnel.

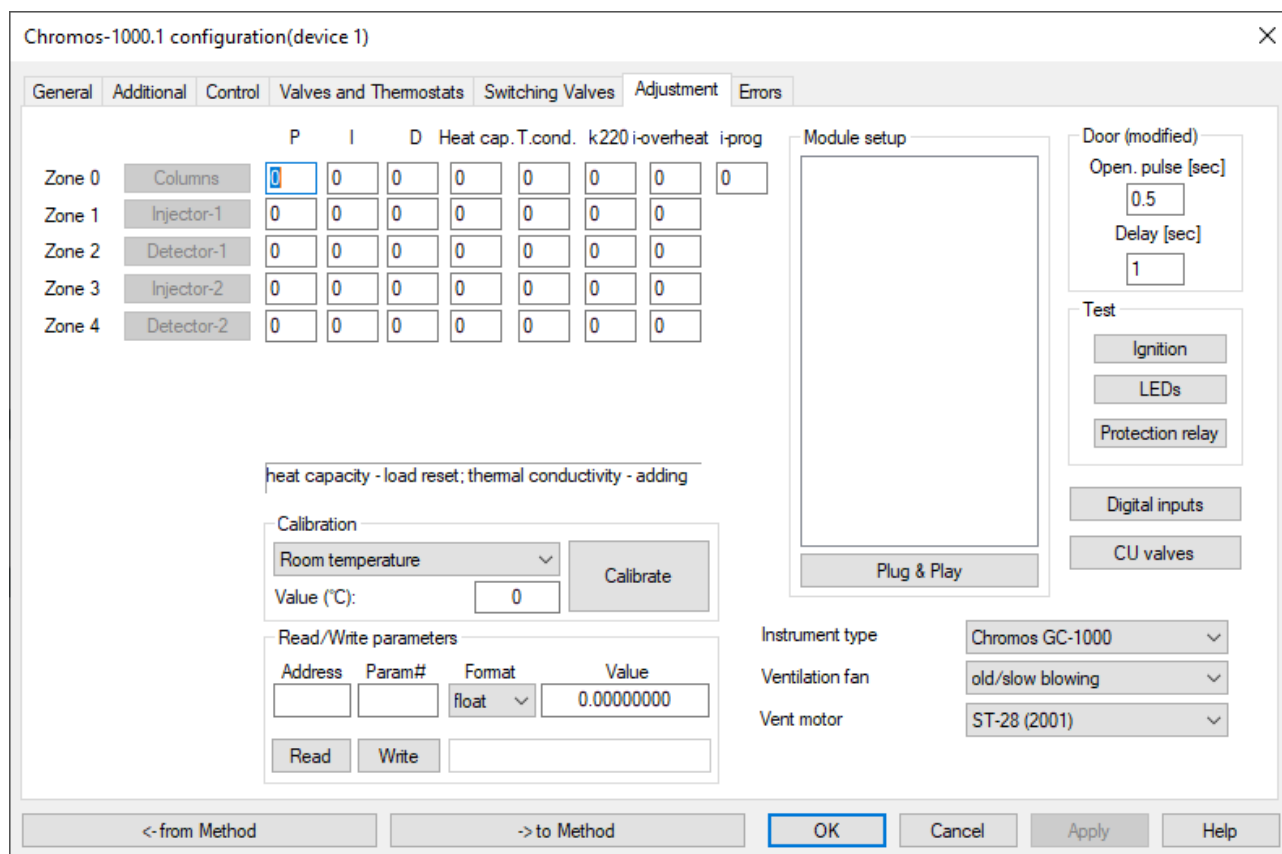







Fig. 38: Chromos GC-1000.1 Configuration > Adjustment

6.9. Creating an Analysis Method

A chromatographic study requires creating an analysis method. Some settings are selected directly when the method is created, and the device parameters are added to the method file during the device configuration (see [Sec. 6.5. Launching the Instrument](#)).

To create a new method:

1. In the *Method* menu, select **New**. The *Method* window opens.
2. In the *Data Collection* tab, select the analysis settings:
 - In the *Analysis time* field, enter the analysis time (in minutes).
 - To set fixed boundaries along the vertical axis of signal at the start of chromatogram recording, select the **Fixed borders** checkbox and enter minimum and maximum values in relevant fields.
 - To display not found components, select the **Show components not found** checkbox.
 - To configure the saving of chromatograms, select the **Save chromatograms to directory** checkbox and enter the directory path.
1. In the *Components* tab, specify the list of components (peaks) that are identified in this method:
 - To add a component, click  **Add**. The *Component* window opens.
 1. In the *Component* window, select a component from the list or enter it manually.
 2. Click **OK**.
 3. In the *Method* window, in the *Components* tab, enter time (in minutes), window, unit of measurement, reference peak, index, maximum, and group values for the selected component.
 - To delete a component, select it and click  **Delete**.
 - To delete all components, click  **Delete all**.
1. In the *Calibration* tab, specify the method for calculating calibration factors and its parameters (for more information, see [Sec. 6.28.2. Calibration Factors Calculating](#)).
2. In the *Report* tab, specify parameters for creating a chromatogram report. For more details on these settings, see [Sec. 6.21.1. Generating a Chromatogram Report](#).
3. In the *Channels* tab, specify channels you want to use for recording, and configure parameters for peak auto-marking:
 - To edit a channel:
 1. Select a channel from the channel list or create a new channel, click  **Add**.
 2. In the *Channel* section, in the text field, enter a channel name.
 3. In the *Channel* section, select a channel number from the dropdown list.
 - To delete a channel, select it and click  **Delete**.
 - To delete all channels, click  **Delete all**.
 - In the *Automatic integration*, *Events*, and *Filter* tabs, specify the auto-marking parameters (see [Sec. 6.15. Configuring the Peak Auto-Marking](#)).
1. In the *Passport* tab, configure the chromatogram passport template. For more details on how to fill in a chromatogram passport, see [Sec. 6.20.1. Filling in a Chromatogram Passport](#).
2. In the *Information* tab ([Fig. 39](#)), specify information about the method:
 - In the *Short description* field, enter the (analysis) method name.
 - In the *Notes* field, enter a comment for the method.

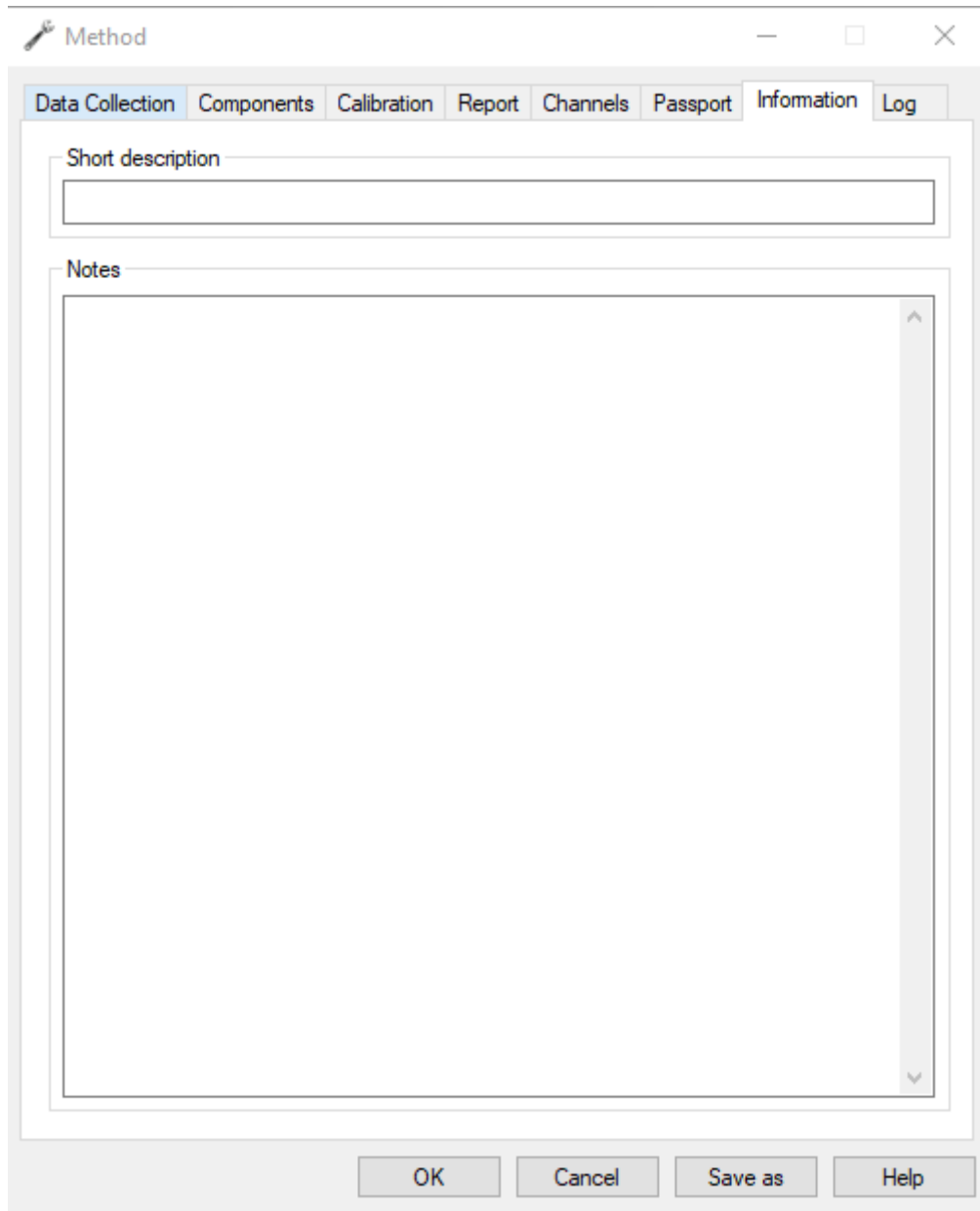

Fig. 39: Method > Information

Note: Information about changes made to the method is displayed in the *Log* tab.

1. Click **OK** or **Save as**.
2. Enter the file name and click **OK**.

The method has been created. Now you can add device settings to it.

6.10. Opening a Chromatogram

To open a chromatogram file:

1. On the control panel, click  **Open**. This function is also available in the *Chromatogram* menu. The *Select Analysis* window opens (Fig. 40).

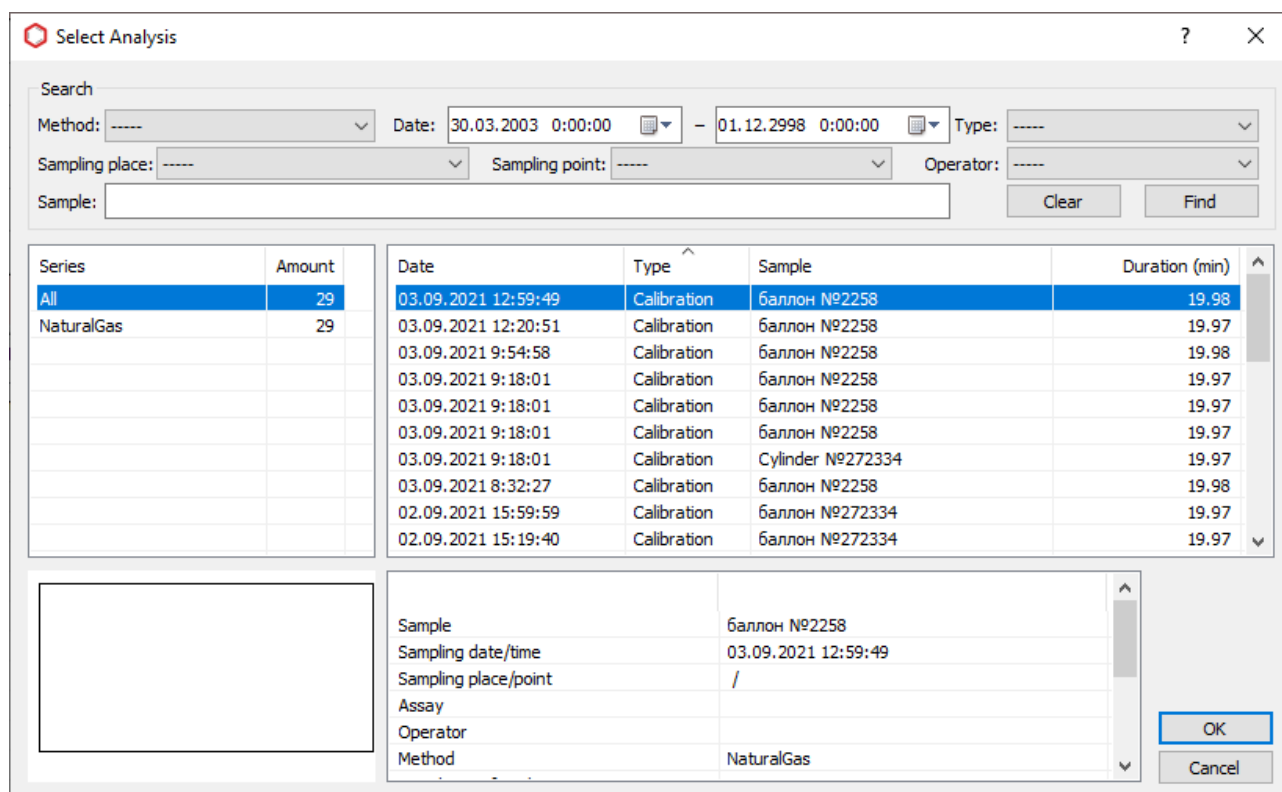





Fig. 40: *Select Analysis*



1. (Optional) In the *Search* section, set search filters. There are the following filters:
 - Method;
 - Date Interval;
 - Type (Analysis/Calibration);
 - Operator;
 - Sampling Place;
 - Sampling Point;
 - Sample.
1. Click **Search**.
2. Select a series. By default, all series are displayed.
3. Select the desired chromatogram.
4. Click **OK**.

6.11. Recording a Chromatogram

To record a chromatogram, first you need to configure the instrument (see [Sec. 6.7. Configuring the Instrument](#)) and create an analysis method (see [Sec. 6.9. Creating an Analysis Method](#)). After the instrument is configured and the method is created, do the following:

1. To connect the instrument, click  **Connect**.
2. To add a series of analysis, click  **Add Series**. The *Measurement Series* window opens.
3. In the *Measurement Series* window, in the *Series* field, enter the name of a new series or select an existing series from the list.
4. In the *Method* field, select a method from the list.
5. Click **OK**.
6. To start the analysis, click  **Launch**. The *Launch* window opens.

Note: Recording channels are configured via *Method > Channels*.

1. To start recording, click **Start recording**.
2. Inject the sample into the chromatograph and press **Start/Stop** on the chromatograph front panel. Chromatogram recording begins.
3. To increase the recording time, click  **Increase Analysis Time**.
4. To stop recording, click  **Stop Recording**.

During recording, you can fill in the passport of the current chromatogram or work on already recorded chromatograms. After the recording ends, the program automatically switches to the mode of auto-marking and identification of the obtained chromatogram.

6.12. Scheduling

To automate the operation of devices, use the scheduler. In the scheduler ([Fig. 41](#)) you can create and run a measurement series for analysis or calibration. The scheduler window contains indicators for the connection of the chromatograph and the sampler, and also displays information about the series of analyzes.

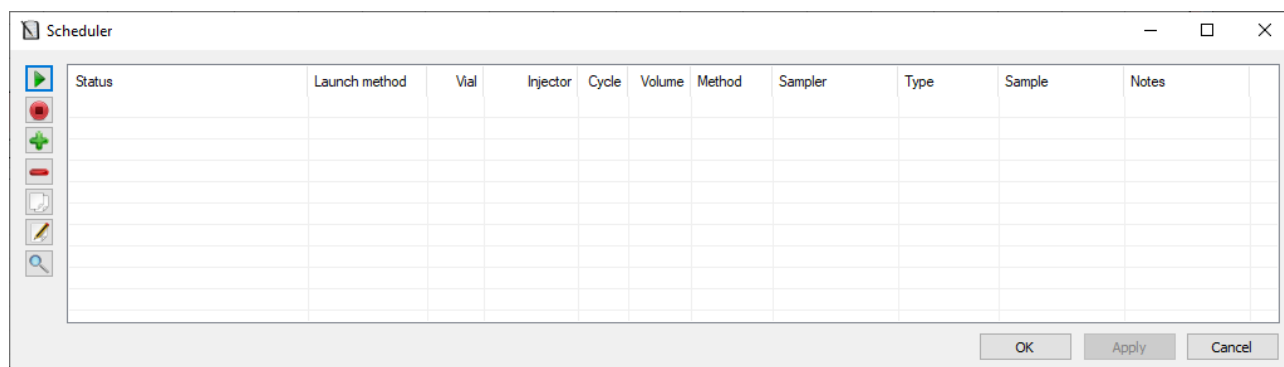









Fig. 41: Scheduler

To schedule a measurement series, do the following:

1. On the toolbar, click  **Scheduler**. The *Scheduler* window ([Fig. 41](#)) opens.
2. To create a new task, click  **Add Task**. The job entry is added to the table.
3. (Optional) To duplicate a task, click  **Create a copy of the current task**.

4. (Optional) To delete the selected task, click  **Delete Task**.
5. To set a parameter, double-click in the corresponding cell and select or enter the desired value.
6. To open the sampler settings window, click  **Sampler configuration**.
7. To run a measurement series, click  **Start measurement series**.
8. To stop a measurement series, click  **Stop measurement series**.

6.13. Noise Estimating

Chromos SW allows to assess the level of fluctuation noise and baseline drift in any section of the chromatogram rapidly and without interrupting the chromatogram recording. This function is used to prepare the instrument for verification. Noise and drift standards depend on the detector.

To start a noise assessment:

1. While recording the chromatogram, press the N key. A vertical pointer tied to the position of the cursor appears in the chromatogram (Fig. 42).

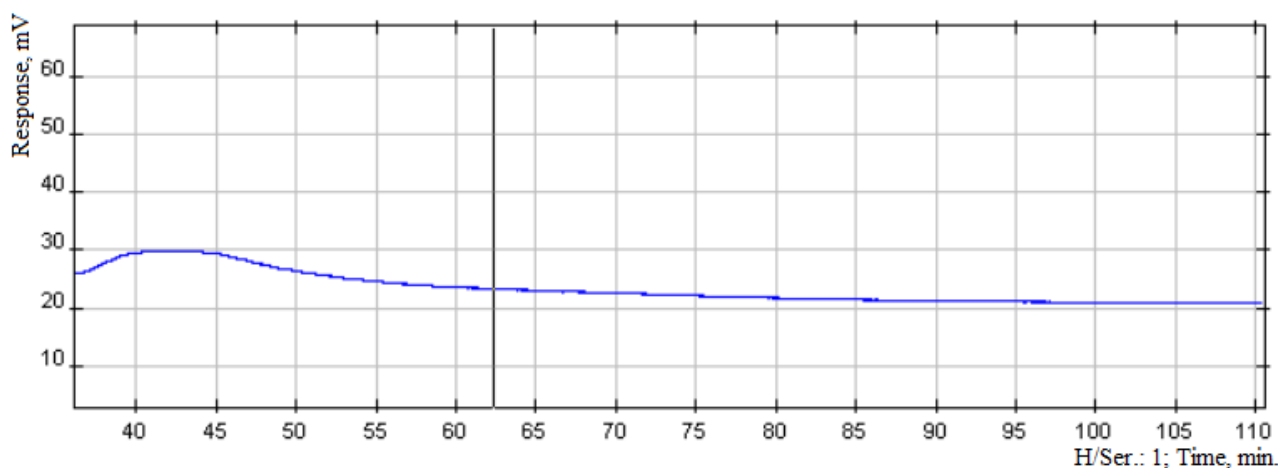

Fig. 42: Selecting the Analysis Section

1. Select the start and the end of the analysis section. A window opens with noise and drift values (Fig. 43).

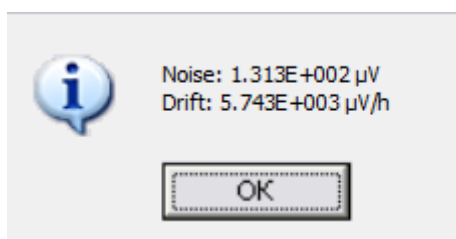

Fig. 43: Calculated Noise and Drift

2. Multiply the drift and noise values by conversion factor 10^{-10} A/ μ V to compare the resulting values with standards established for stream detectors.

6.14. Peak Auto-Marking

Chromatogram auto-marking (autointegration) is performed in three stages:

1. Marking of required peaks.
2. Baseline marking.
3. Filtering of small peaks.

At the first stage, it is necessary to mark all the required peaks. Two parameters are used for this: *Width* and *Width Doubling*.

The second stage includes configuring the grouping of peaks with a shared baseline and the marking of shoulders. The *Maximum Distance Between Peaks with a Common Baseline* parameter is set for the grouping, and the *Maximum Shoulder Area* parameter is set for the shoulders.

The third stage (filtering) includes eliminating small or too wide peaks. Filtering is configured using such parameters as *Marking Start*, *Minimum Height*, *Maximum Width*, and *Minimum Area*.

If any marking parameter needs to be changed in the chromatogram section, the event module is used.

Below are explanations of the above parameters.

6.14.1. Width

Width is the main parameter for detecting peaks. The peak width is calculated by the peak base and displayed in the *Width* column in the table below the chromatogram (Fig. 44).

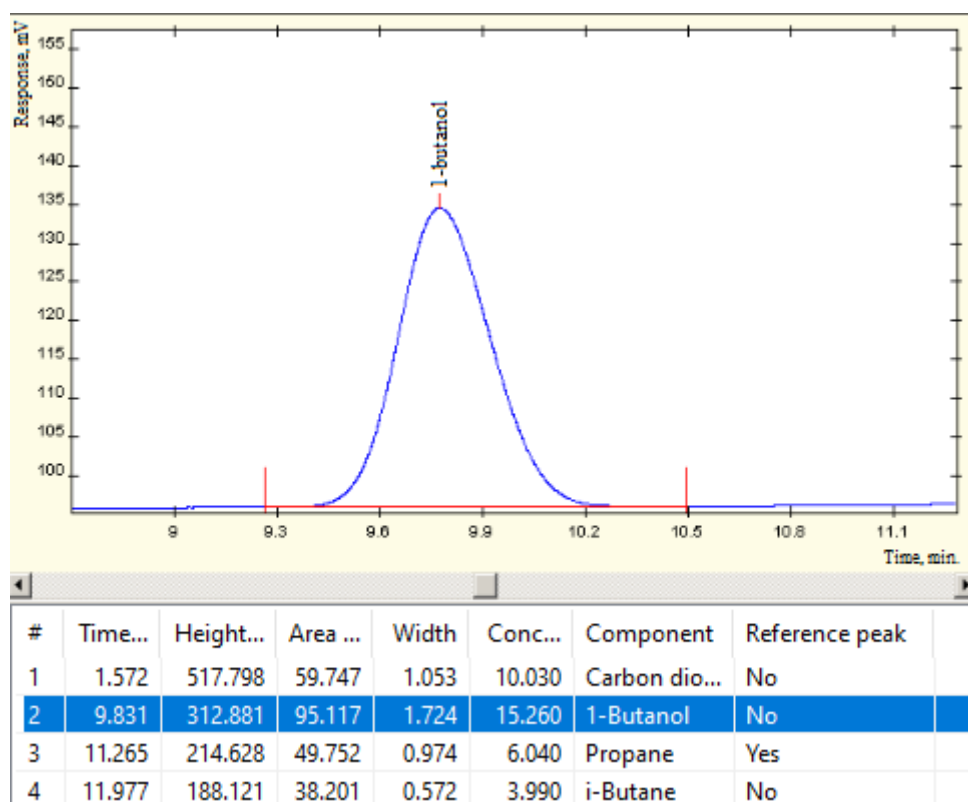

Fig. 44: Peak Width

To select a value for this parameter, mark the chromatogram manually. After marking, in the table below the chromatogram find the narrowest peak whose width is minimal. In the *Width* field, enter a value slightly less than the width of the narrowest peak.

In complicated cases, when the baseline in the chromatogram is unstable or there is a large drift, the peaks may be marked incorrectly.

For example, the figures below show the peak width of min. 0.28. In Fig. 45 the peak is marked incorrectly since the width parameter is set too high. In Fig. 46 the width parameter is less than the actual peak width, so the peak is marked more accurately. If a more accurate result is required, you can reduce the width value as shown in Fig. 47.

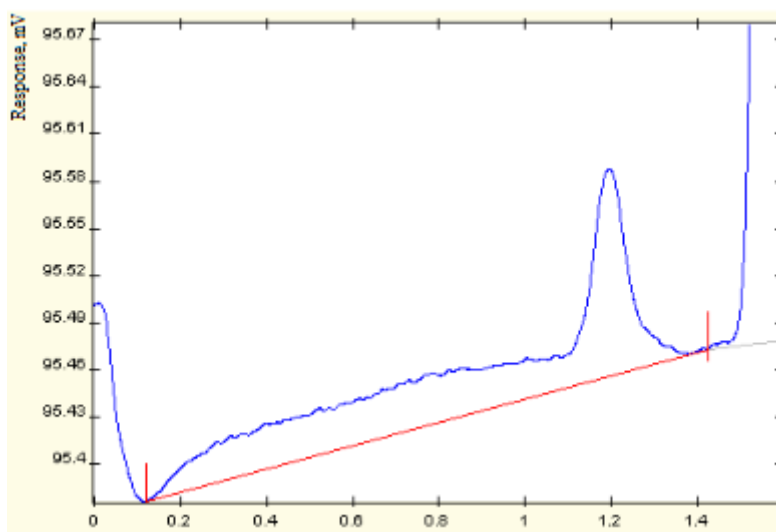

Fig. 45: Width = 0.4

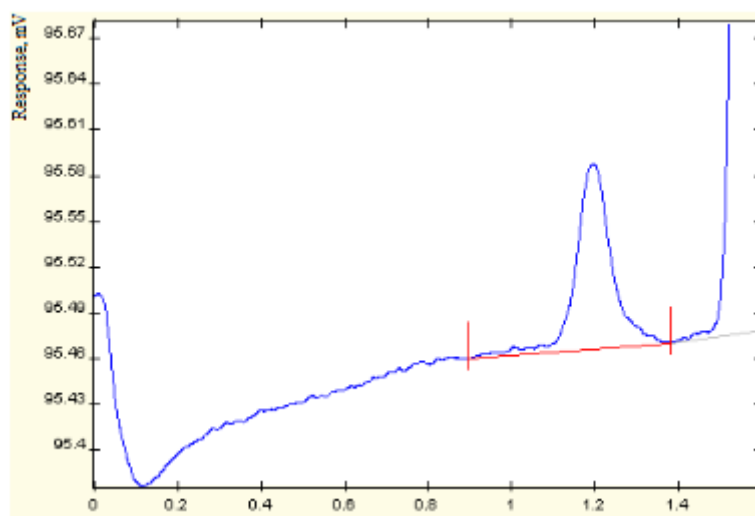

Fig. 46: Width = 0.1

6.14.2. Width Doubling

In chromatograms the first peaks are normally narrower than the subsequent ones, since the width increases as the peaks migrate. The *Width Doubling* parameter indicates how long it will take for the peak width to double. If you need to accurately calculate this parameter, use the following formula (Eq. 1):

$$W_{exp} = 2 * \frac{W_1}{W_2} * (t_2 - t_1) \quad (1)$$

In the given formula Eq. 1:

- W_{exp} – width doubling;
- W_1 – peak width at the chromatogram start;

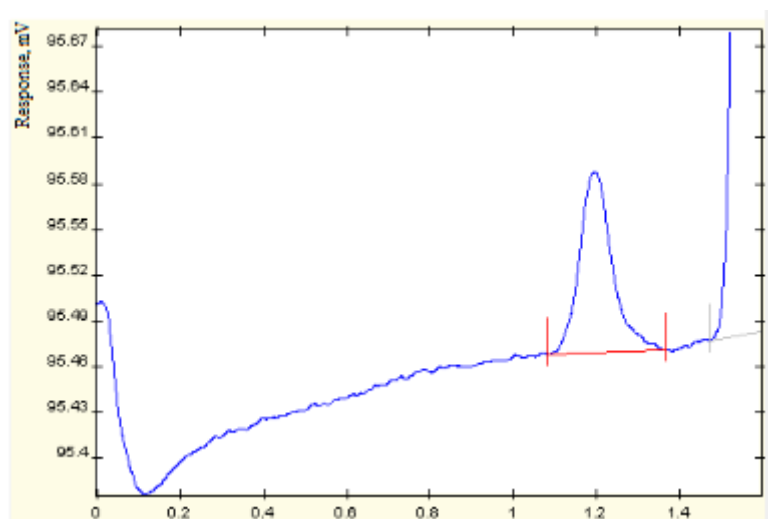
Fig. 47: $Width = 0.01$

- W_2 – peak width at the chromatogram end;
- t_1, t_2 – relevant peak exit time.

For example, if at the chromatogram start ($t_1 = 1$ min) the peak width is = 0.5 min, in the chromatogram middle ($t_2 = 7$ min) the peak width is = 2 min, then the *Width Doubling* parameter should be set to 3 min.

If this parameter is unclear, set it to zero.

6.14.3. Maximum Distance Between Peaks with a Common Baseline

This parameter allows to group close peaks with a shared baseline. If time between adjacent peaks is less than the value of this parameter, the program will unite these peaks into a group with a shared baseline.

For example, in Fig. 48 the maximum distance between peaks is set to 0.7, so there are two groups of peaks. In Fig. 49 this parameter is set to 1 and there is one large group of peaks.

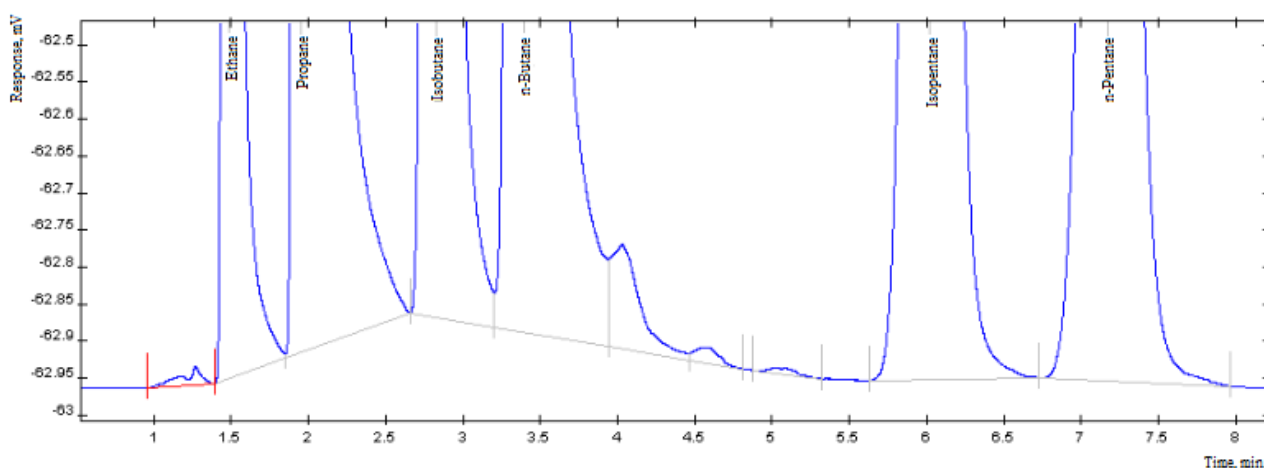
Fig. 48: $Maximum\ Distance = 0.7$. Two Groups

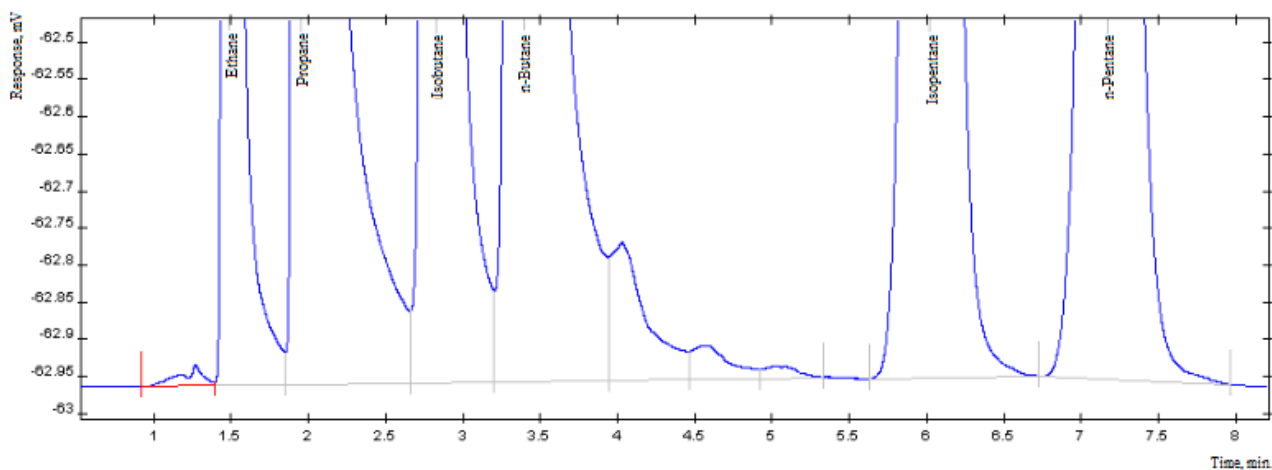

Fig. 49: Maximum Distance = 1. One Group

6.14.4. Maximum Shoulder Area

This parameter determines which peaks are to be considered as shoulders. If the peak area is less than a setpoint, such peak is considered a shoulder.

For example, in Fig. 50 the maximum shoulder area is set to zero, so there are no shoulders. In Fig. 51 this parameter is set to 1 and the chromatogram has shoulders.

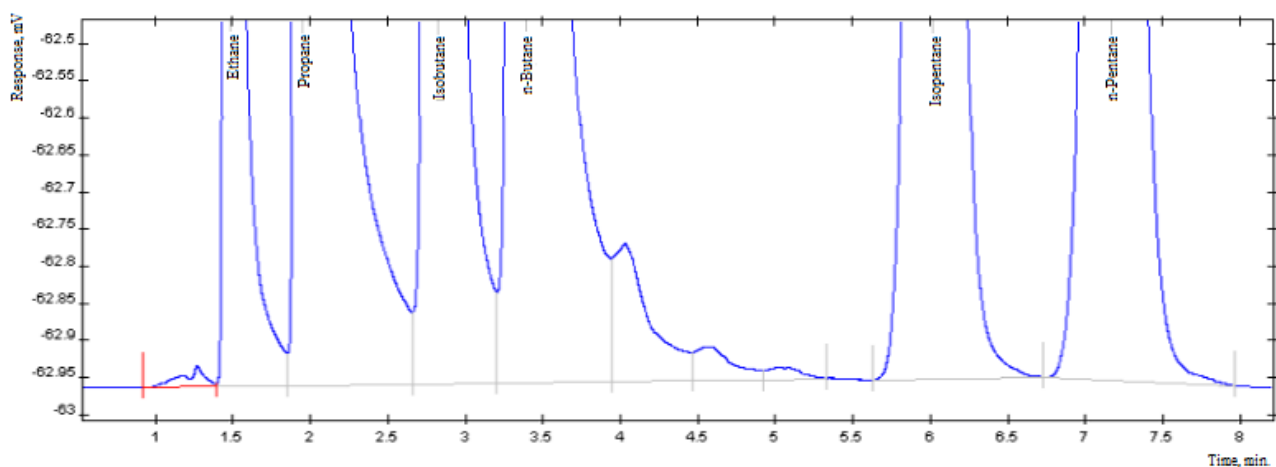

Fig. 50: Maximum Shoulder Area = 0. There are no shoulders

If no shoulders are required for the analysis, set this parameter to zero.

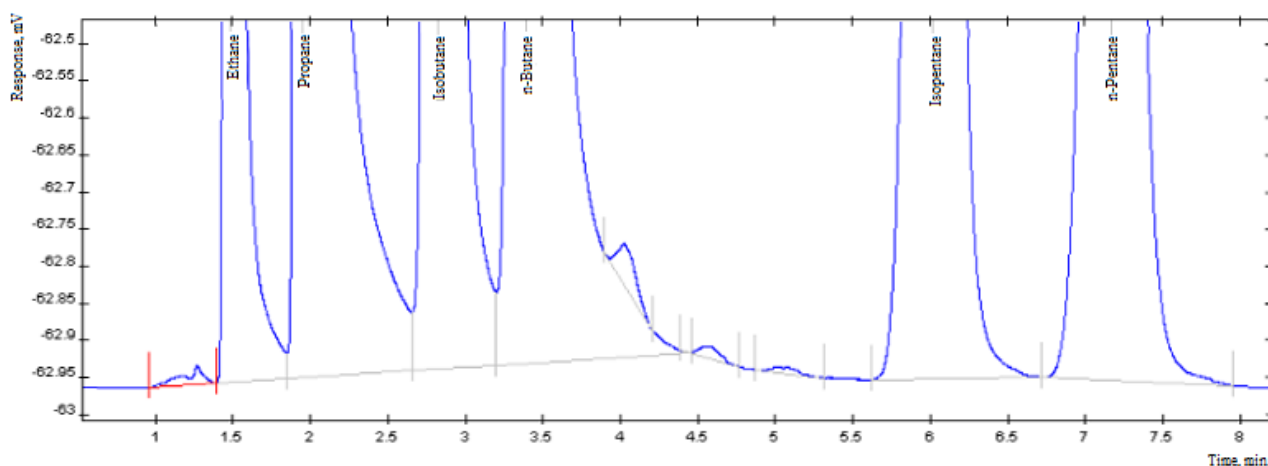

Fig. 51: Maximum Shoulder Area = 1. There are shoulders

6.14.5. Marking Start

This option allows to skip auto-marking at the chromatogram start. No peak marking will be performed until the specified time.

6.14.6. Minimum Height

This parameter determines the minimum height of the identified peak and helps eliminate small peaks.

6.14.7. Minimum Area

This parameter determines the minimum area of the identified peak and helps eliminate small peaks.

6.14.8. Maximum Width

This parameter determines the maximum width of the identified peak and helps eliminate too wide peaks.

6.14.9. Disable/Enable Peak Marking

This parameter is used in the event module. It enables or disables restrictions on peak marking.

6.14.10. Merge Peaks/Stop Peak Merging

This parameter is used in the event module. It starts and stops the merging of peaks.

6.14.11. Enable/Disable Negative Peak Marking

This parameter is used in the event module. It starts and stops the marking of negative peaks.

6.14.12. Move Baseline Left/Right

This parameter is used in the event module. It works as follows: at the specified time there is a signal level (point on the signal curve), and a horizontal baseline is drawn to the left or right from this level until it intersects the signal curve.

6.14.13. Filtering

For peak auto-marking, filters can be used. See [Sec. 6.15.1. Filtering](#).

For more details on how to configure the peak auto-marking, see [Sec. 6.15. Configuring the Peak Auto-Marking](#).

6.15. Configuring the Peak Auto-Marking

In the analysis method settings, you can set parameters for peak auto-marking in the chromatogram. The parameter values are described in [Sec. 6.14. Peak Auto-Marking](#).

To configure the peak auto-marking:

1. In the *Method* menu, click **Open...** and select the method in the dialog box, or click **New** and create a new one.
 2. In the *Method* window, go to the *Channels* tab ([Fig. 52](#)).
 3. In the *Channels* tab, select the desired channel or click  **Add** and create a new one.
1. In the *Channels* tab, go to the *Auto-Marking* tab and set the auto-marking parameters:
 - In the *Width* field, enter the minimum peak width value (in minutes).
 - In the *Width Doubling* field, enter the calculated time it takes the peak width to double (in minutes).
 - In the *Maximum Distance Between Peaks with a Common Baseline* field, enter the relevant distance value (in minutes).
 - In the *Maximum Shoulder Area* field, enter the shoulder area value (in mV*min).
 - In the *Marking Start* field, enter the time from which the chromatogram is to be auto-marked (in minutes).
 - In the *Minimum Height* field, enter the minimum height of the identified peak (in mV).
 - In the *Minimum Area* field, enter the minimum area of the identified peak (in mV*min).
 - In the *Maximum Width* field, enter the maximum width of the identified peak (in min).
 1. (Optional) In the *Channels* tab, go to the *Events* tab.
 - To edit an event:
 1. Either select an existing event in the list and click **Edit** or click **Add** and create a new one. The *Event* window opens.
 2. In the *Event* window, select an event from the list.
 3. In the *Start at* field, specify the time (in minutes) from which this event is to run.
 4. In the *Additional Parameter* field, specify any additional parameters, if available.
 - To delete an event, select it from the list and click **Delete**.
 - To delete all events, click **Delete all**.
 1. (Optional) In the *Channels* tab, go to the *Filter* tab.
 - To add a filter, in the *Chromatogram Filtering* field, select a filter from the list and enter the

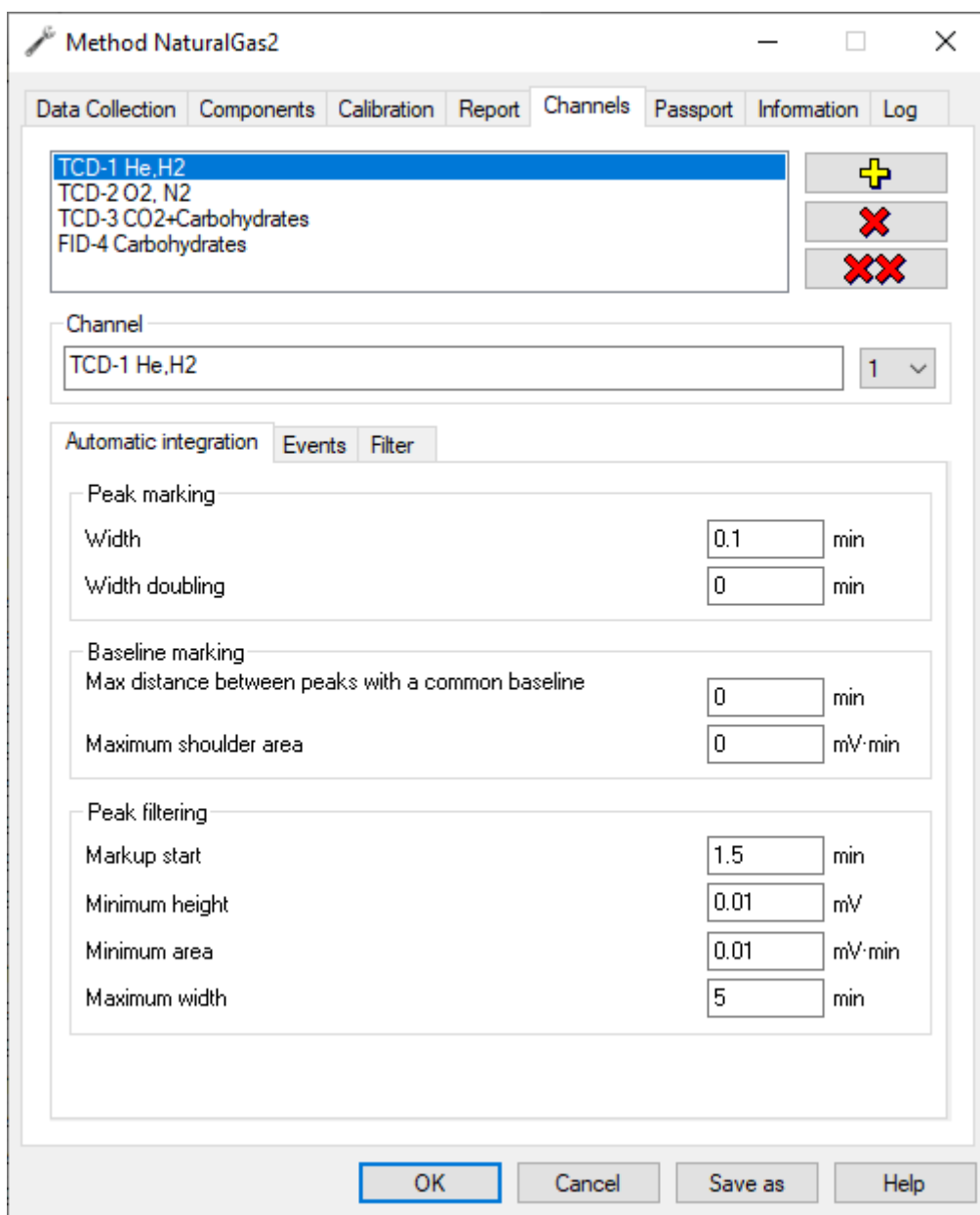

Fig. 52: Method > Channels

size of the gap (in seconds) by which the filtering will be performed.

- To subtract a baseline, in the *Baseline Subtraction* field, select the *Enable Zero Line Subtraction* checkbox.
1. To save the settings, click **Save as** or **OK**.

6.15.1. Filtering

There are the following filters in the auto-marking settings:

- None (no filter);
- Median;
- Gaussian;
- Outliers;
- LFF (low-frequency filter);
- SLF (suppression line filter).

You can also enable baseline subtraction in the filtering settings. Chromatogram baseline is a line corresponding to a zero concentration of analytes. It is obtained from a “blank” run. Blank run is a procedure for analyzing a substance or material without an analytical sample or with a blank sample. A blank chromatogram is required due to usual baseline instability, and the blank chromatogram result is subtracted from the sample analysis result to eliminate the area sector unrelated to the sample from the chromatographic data.

6.16. Manual Peak Marking

Manual peak marking allows to adjust auto-marking results. You can move peak boundaries, add or remove a peak, delete all peak markings and add an unsplit peak on the left or right.

To work with the peak, you need to select it in the chromatogram. In Fig. 53 black vertical lines mark the peaks, and boundaries of the selected peak are highlighted in red.

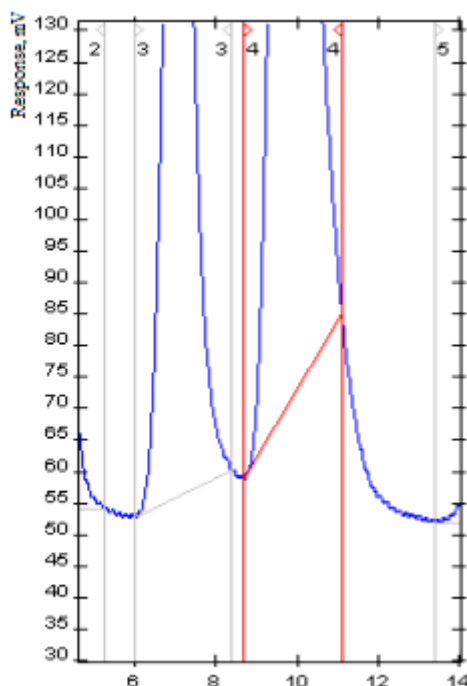

Fig. 53: Peak Selected from Marked Ones

6.16.1. Configuring the Manual Peak Marking

6.16.1.1 Moving Peak Boundaries

1. Select a peak.
2. To move the peak boundary, click it, and holding down your left mouse button, move the boundary to the desired position (Fig. 54).

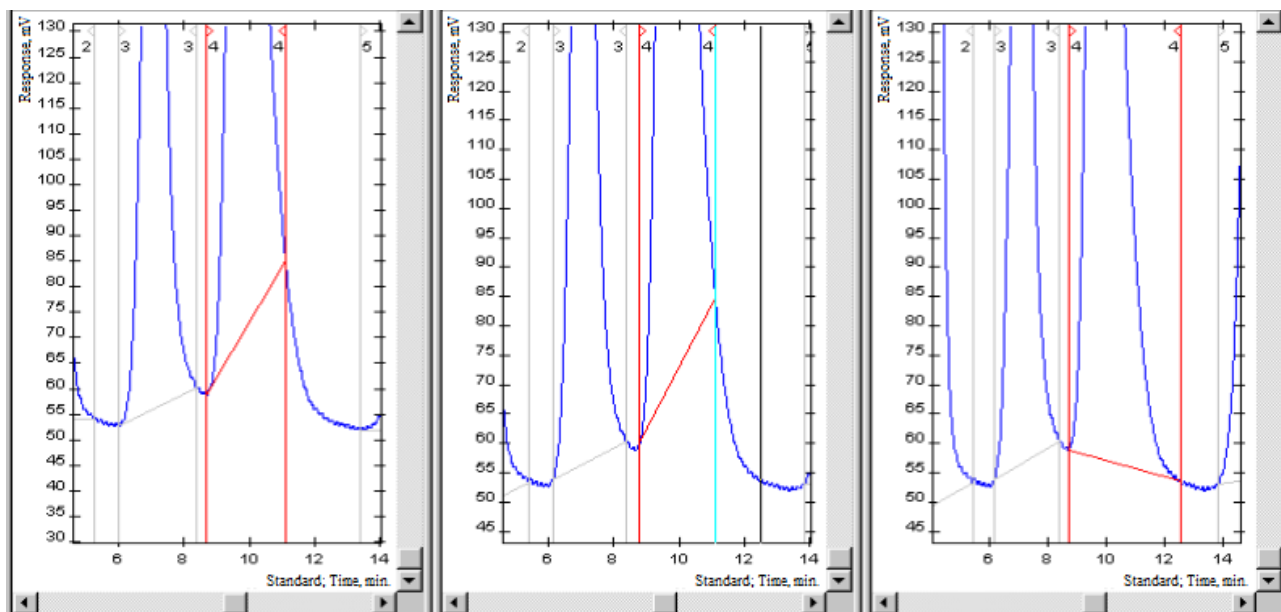



Fig. 54: 1) Selected peak. 2) Moving peak boundary. 3) Result.

6.16.1.2 Adding a Peak

1. To add a new peak, click  **Add Peak**.
2. In the chromatogram, mark the peak start and end boundaries (Fig. 55).

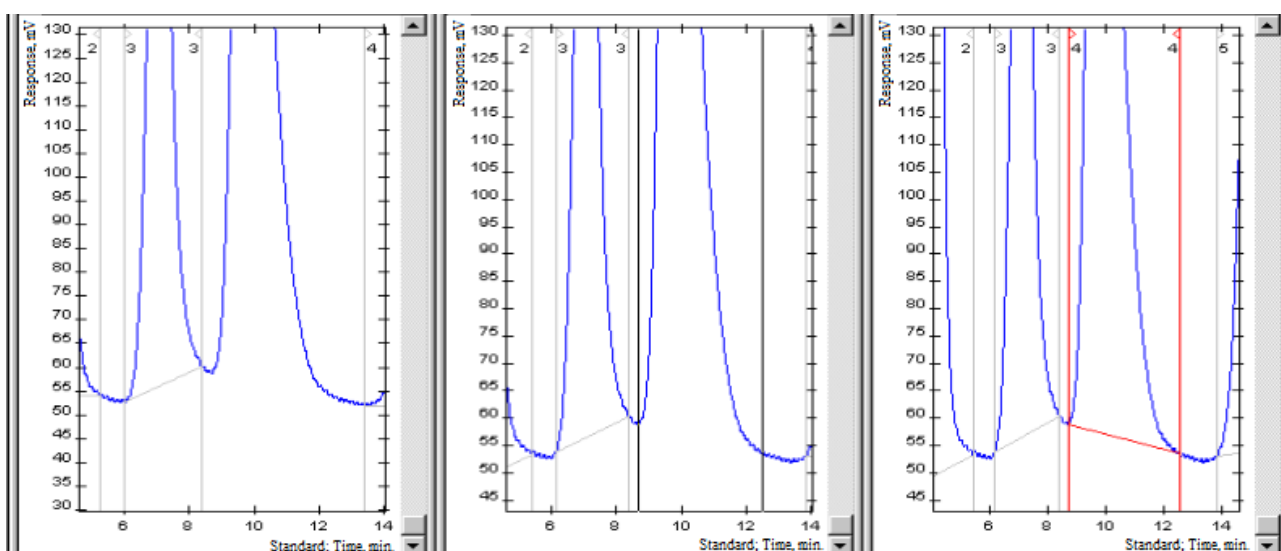



Fig. 55: 1) Initial marking. 2) New peak boundary identification. 3) Result.

6.16.1.3 Adding an Unsplit Peak

1. Select a peak.
2. To add an unsplit peak on the left or right to the selected peak, click  **Add Unsplit Left** or  **Add Unsplit Right**, respectively.
3. Note the boundary of the unsplit peak (Fig. 56).

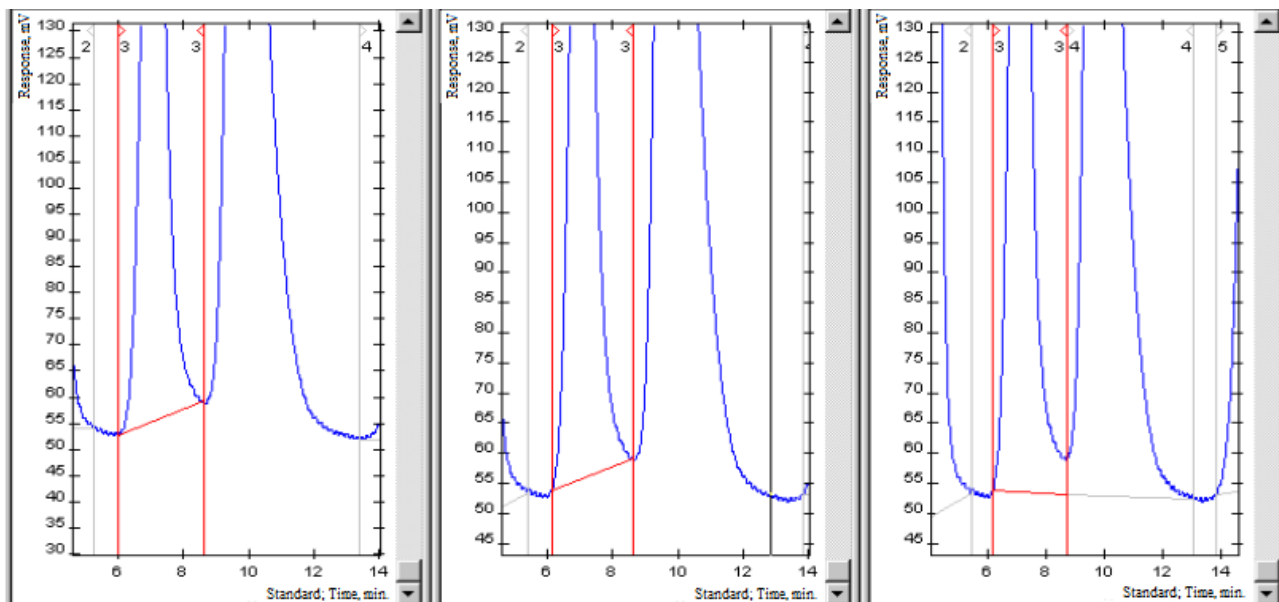



Fig. 56: 1) Initial marking. 2) Unsplit peak boundary identification. 3) Result.

6.16.1.4 Deleting a Peak

1. Select a peak.
2. To delete the selected peak, click  **Delete Peak**.

6.16.1.5 Deleting All Peaks

- To delete all peak marking, click  **Delete All Peaks**.

6.17. Selected Peak Marking

To auto-mark a specific section of the chromatogram, do the following:

1. To delete the auto-marking results, click  **Delete All Peaks**.
2. In the *Data* menu, select **Area Auto-Marking**. A vertical pointer tied to the position of the cursor will appear in the chromatogram.
3. Click to select the start and the end of the section for analysis.

6.18. Creating a Peak Group

Chromos SW allows to unite substances into groups. To create groups of substances (peak groups):

1. Calibrate the instrument (see [Sec. 6.28.1. Plotting a Calibration](#)).
2. To save the method, click **Save as**.
3. In the *Method* window, go to the *Components* tab (Fig. 57):

#	Name	Chan...	Time, min	Wind...	Unit	Re...	In...	Max	Group
1	Helium	1	1.69	5		No	0		111
2	Hydrogen	1	2.18	5		No	0		222

Fig. 57: Method > Components

1. In the *Group* column, double-click in the box next to the desired component and enter the group name/number.
2. To save the changes, click **OK**.

6.19. Peak Identification

Peak identification is the process of matching the peak table with the component table (see also [Sec. 5.2.4. Chromatogram Window](#)).

To identify peaks, use parameters in the *Components* tab of the *Method* window.

Table 4: Parameters Used for Identification

Parameter	Description
Name	Component
Time	Retention time
Window, %	Permissible difference between the expected retention time and the actual retention time, measured as a percentage of the expected retention time. For example, with a value of 5, the gap will be $\pm 5\%$ of the exit time.

Peaks are identified by time. When identifying peaks, the desired component is determined by the peak which falls within the gap and is closest to the exit time of this component.

When a new calibration point is added, component exit times of all calibration points are recalculated, and average exit time of the component is determined.

For more accurate identification, reference peaks can be used. Relative retention time is calculated for such peaks. The reference peak is chosen from the component table in the *Reference Peak* column by double-clicking in the selected component row.

6.19.1. Identifying Peaks

To identify peaks, do the following:

- On the control panel, click  **Identify peaks**.
- To add calibration data, select an action:
 - To add a component, in the *Method* menu, select + **Components**.
 - To add a calibration point, in the *Method* menu, select + **Calibration Point**.
 - To add a reference peak, in the *Method* menu, select + **Reference**.

After any of these actions, the *Method* window opens in the *Calibration* tab, where you need to set other parameters. See [Sec. 6.28.1. Plotting a Calibration](#).

- To display the component exit windows, in the *Chromatogram* menu, select **Options...** The

Options window opens. In the *View* tab, select the **Show method peak exit windows on chromatogram** checkbox.

6.20. Chromatogram Passport

A chromatogram passport contains general information about a chromatogram (date, name, ID) and a sample, as well as additional parameters that can be set manually (see [Sec. 6.20.1. Filling in a Chromatogram Passport](#)).

The following table describes the parameters entered into the chromatogram passport:

Table 5: Chromatogram Passport Parameters

Parameter	Description
ID	Unique analysis identifier
File	Chromatogram file name
Analysis	Analysis name
Date of measurement	Measurement date and time
Duration of analysis	Analysis duration
Series	Series name
Sample name	Sample name
Method	Method used in the analysis
Reject	Shows whether it is a reject or not
Mixture	Mixture number
Calibration	Selector of a calibration/analysis chromatogram type
Sampling date/time	Sampling date and time
Column	Column information
Eluent	Eluent
Eluent. Flow	Eluent flow rate
Eluent. Pressure	Eluent pressure
Reagent	Reagent
Reagent. Flow	Reagent flow rate
Reagent. Pressure	Reagent pressure
Reagent. Temperature	Reagent temperature
Detector	Detector information
Injector number	Injector number
Operator	Operator's name
Sampling place	Sampling place information
Sampling point	Sampling point information
Series number	Analysis number in the series
Vial number	Vial number
Sample volume	Sample volume value (required for absolute calibration calculation)
Dilution	Dilution value (required for absolute calibration calculation)
Standard mass	Mass of standard (required for calculation using the standard)
Norm (100%)	Maximum norm (100% of substances undetermined by the detector)
Sample mass	Mass of sample (required for calculation using the standard)
Ambient pressure (kPa)	Ambient pressure (kPa)
Ambient temperature (°C)	Ambient temperature (°C)

continues on next page

Table 5 – continued from previous page

Parameter	Description
Gas parameters	Gas parameters (for GC)
Temperature parameters	Temperature parameters (for GC)
Additional parameters	Additional parameters
Notes	Additional notes to the chromatogram

6.20.1. Filling in a Chromatogram Passport

When running an analysis and saving a chromatogram file, some data (ID, date, file name, etc.) are recorded in the chromatogram passport automatically. Additional information can be entered manually.



For parameters specified in the chromatogram passport, see [Sec. 6.20. Chromatogram Passport](#).

To fill in a chromatogram passport, do the following:

1. Open the chromatogram file.
2. On the control panel, click  **Chromatogram Passport**. This function is also available in the *Chromatogram* menu. The *Passport* window opens.
3. (Optional) To add a parameter, in the *Passport* window, click  **Add** and select a parameter from the list.

Note: The *Other* parameter allows to create a new parameter.

Note: Each parameter can be entered only once. If the parameter is already present in the chromatogram passport, the program will issue an appropriate warning.

1. Set the parameter value. Depending on the parameter, you can enter a value manually, select a value from the list of existing values, or edit data in a separate window:
 - To enter a parameter value manually, in the *Values* column, double-click the relevant field and enter the value.
 - To select a value from the list of existing values, in the relevant field in the *Values* column, click  **Open List** and select the value.
 - To open a data editing window, in the relevant field in the *Values* column, click  **Parameters** and set the parameters in the opened window.
1. To save the changes, click **OK**.

6.21. Chromatogram Report

Chromos SW allows to create a chromatogram report which can then be saved to disk and printed.

The report may include the following data:

- General information – report generation time, chromatogram file name and analysis duration.
- Chromatogram of a specified size.
- Peaks – including their number, name and exit time.
- Sample parameters indicated in the Passport.
- Column specifications indicated in the Passport.

- Procedure – analysis method and calibration parameters.
- Eluent specifications and temperature components indicated in the Passport.
- Reagent specifications and gas components indicated in the Passport.
- Notes.
- Component table from the *Chromatogram* window.
- Group table – total height, area and concentration for each group.
- Calibration – calibration plot and formulas for each selected component.

You can also configure the automatic generation, printing and export of a report to a file.

For more details on how to generate a report, see [Sec. 6.21.1. Generating a Chromatogram Report](#).

6.21.1. Generating a Chromatogram Report

To select report settings, navigate to *Method > Report* (Fig. 58).

The screenshot shows the 'Report parameters' dialog box with the following settings:

- Sections:**
 - General information
 - Sample
 - Column
 - Method
 - Eluent/Temperatures
 - Reagent/Gases
 - Notes
 - Component table
 - Groups
 - Calibration
- Peak names:**
 - Number
 - Name
 - Exit time
 - Vertical (dropdown menu)
- Chromatogram:**
 - Chromatogram
 - 6 x 8 cm (dropdown menu)
- Calibration:**
 - Helium
 - Hydrogen
 - Oxygen
 - Nitrogen
 - Carbon dioxide
 - Ethane
- Automation:**
 - Generate automatically
 - Print automatically
 - Export automatically

Buttons: OK, Отмена, Справка

Fig. 58: Chromatogram Report Settings

To configure the chromatogram report parameters, do the following:

1. In the *Method* window, go to the *Report* tab.

2. In the *Sections* section, select the information to add to the report (for description, see [Sec. 6.21. Chromatogram Report](#)).
3. In the *Peak names* section, select the peak information to add to the report.
4. To include a chromatogram in the report, in the *Chromatogram* section, check the box and select the chromatogram size from the dropdown list.
5. If in the *Sections* section, the *Calibration* option is selected, in the *Calibration* section, select the components for which calibration information will be added.
6. For automatic report generation, select **Generate Automatically**.
7. For automatic report printing, select **Print Automatically**.
8. For automatic report export to a file, select **Export Automatically**.
9. To save the settings, click **Save as** or **OK**.

6.21.2. Opening a Chromatogram Report

To open a chromatogram report, do the following:

1. In the *Chromatogram* menu, select **Open Report...** The *Open Report* window opens.
2. Select the report file and click **Open**.

6.21.3. Printing a Chromatogram Report

Printing a chromatogram report includes configuring the report content and sending the data to print. Print parameters are set in the system window (see [Sec. 8.3. Configuring Print Parameters](#)). In the *Report Parameters* window, specify information to be recorded in the report (see [Sec. 6.21. Chromatogram Report](#) and [Sec. 6.21.1. Generating a Chromatogram Report](#)).

To print the report, do the following:

1. On the control panel, click  **Print Chromatogram**. The *Report Parameters* window opens.
2. In the *Report Parameters* window, select the necessary information.
3. Click **OK**. The *Print* system window opens.
4. (Optional) In the *Print* window, set the print parameters.
5. In the *Print* window, click **Print**.

6.22. Saving a Chromatogram

Chromatograms are saved to the Chromos SW system directory. To save the chromatograms outside the system directory or to load chromatograms from external folders, use chromatogram exporting, data exporting, and data importing (see [Sec. 6.23. Exporting a Chromatogram](#), [Sec. 6.24. Data Exporting](#), [Sec. 6.25. Data Importing](#)). If you want to save both the original file and the changed one, you need to duplicate the chromatogram (see [Sec. 6.26. Duplicating a Chromatogram](#)).

- To save the chromatogram after changing it, on the control panel, click  **Save**.

6.23. Exporting a Chromatogram

It may be necessary to send the recorded chromatograms to the manufacturer for instrument diagnostics.

To save the chromatogram outside the system directory:

1. In the *Chromatogram* menu, select **Export > <file format>**. The *Export to a <format> file* window opens.
2. Specify the destination folder and click **Save**.

The data is written to a file of the selected format (txt, json, xml, xlsx, csv). You can save the

file on a local drive, on a network drive (ftp, ftps, http, https, smb, nfs), and using *USB Mass Storage Device* on a flash drive as well.

6.24. Data Exporting

In Chromos SW you can export analysis data. To export chromatograms, methods and calibration mixtures data, do the following:

1. In the *Start* menu, navigate to **Chromos 4 > Export**. The program window opens.
2. To add chromatograms, click  **Load chromatograms**. The *Select Analysis* window opens.
3. In the *Select Analysis* window, select the necessary chromatograms and click **OK**.
4. Check the chromatograms which you want to export. To check all the data, in the *UUID* heading, check the box.
5. Click **Export**.
6. Specify the path and click **Save**.

The exported data are saved in a zip archive.

6.25. Data Importing

In Chromos SW you can import analysis data. To load from the external folder chromatograms, methods and calibration mixtures data, do the following:

1. In the *Start* menu, navigate to **Chromos 4 > Import**. The program window opens.
2. Click **Open** and select the zip archive on your device.
3. In *Chromatograms*, *Methods* and *Mixtures* tabs, check the data which you want to import.
4. Click **Import**.

6.26. Duplicating a Chromatogram

If you want to save both the original file and the changed one, you need to duplicate the chromatogram.

- To duplicate the chromatogram, in the *Chromatogram* menu, select **Duplicate**.

6.27. Closing the Program

At the end of the Chromos SW operation, the program checks for any connected instruments and unsaved data. If the instrument is not disconnected or the chromatogram is not saved, the program issues an appropriate warning.

To close the program, do the following:

1. Save the chromatogram file.
2. Disconnect the instrument.
3. In the *Chromatogram* menu, click **Exit** or close Chromos SW.

6.28. Chromatograph Calibration

Chromatograph calibration is a metrological operation to identify any measurement errors, set a standard value, and find relationship between substance concentration and a peak in the chromatogram.

A calibration can be plotted using calibration chromatograms with known component content or manually. To plot a calibration manually, the software allows to manually set calibration factors. To plot a calibration based on calibration chromatograms (by calculating calibration factors), several chromatograms with known component content are recorded and added to the method. To do this, you can use a new method or an existing one. In the latter case, it is necessary to delete an old calibration from the method.

The *Calibration* window (Fig. 59) shows a plot and a table of calibration points. The table of calibration points displays the following parameters:

- # – calibration level number;
- Use – level use in calibration;
- Time, min – peak exit time (in minutes);
- Height, mV – peak height (in mV);
- Area – peak area;
- Quantity – component quantity.

For some calculation methods, the following values are displayed:

- RSD – relative standard deviation of calibration factor;
- Divergence – calibration factor divergence;
- PCC – Pearson correlation coefficient.

For more details on how to plot a calibration, see [Sec. 6.28.1. Plotting a Calibration](#).

6.28.1. Plotting a Calibration

To plot a calibration:

1. Open the method for calibration analysis:
 - To use an existing method, in the *Method* menu, select **Open...** and then select the desired method.
 - To create a new method, in the *Method* menu, select **New**.
1. In the *Method* window, go to the *Calibration* tab.
2. (Optional) To delete previous calibration data from an existing method, click **Calibration**, then in the opened window click  **Delete All Calibration Levels**.
3. In the *Calibration* tab, select the calibration factor calculation method.

Note: For calculation methods and their parameters, see [Sec. 8.6. Standard Method Calculations](#) in the Method. For basic settings, see [Sec. 6.28.2. Calibration Factors Calculating](#).

1. Click **OK**.
2. Record calibration chromatograms using a preset method. See [Sec. 6.28.3. Recording Calibration Chromatograms](#).
3. After recording the calibration chromatogram, in the *Method* menu, select **+ Calibration Point**. The *Calibration* tab of the *Method* window opens.
4. Click **Calibration**. The *Calibration* window opens.

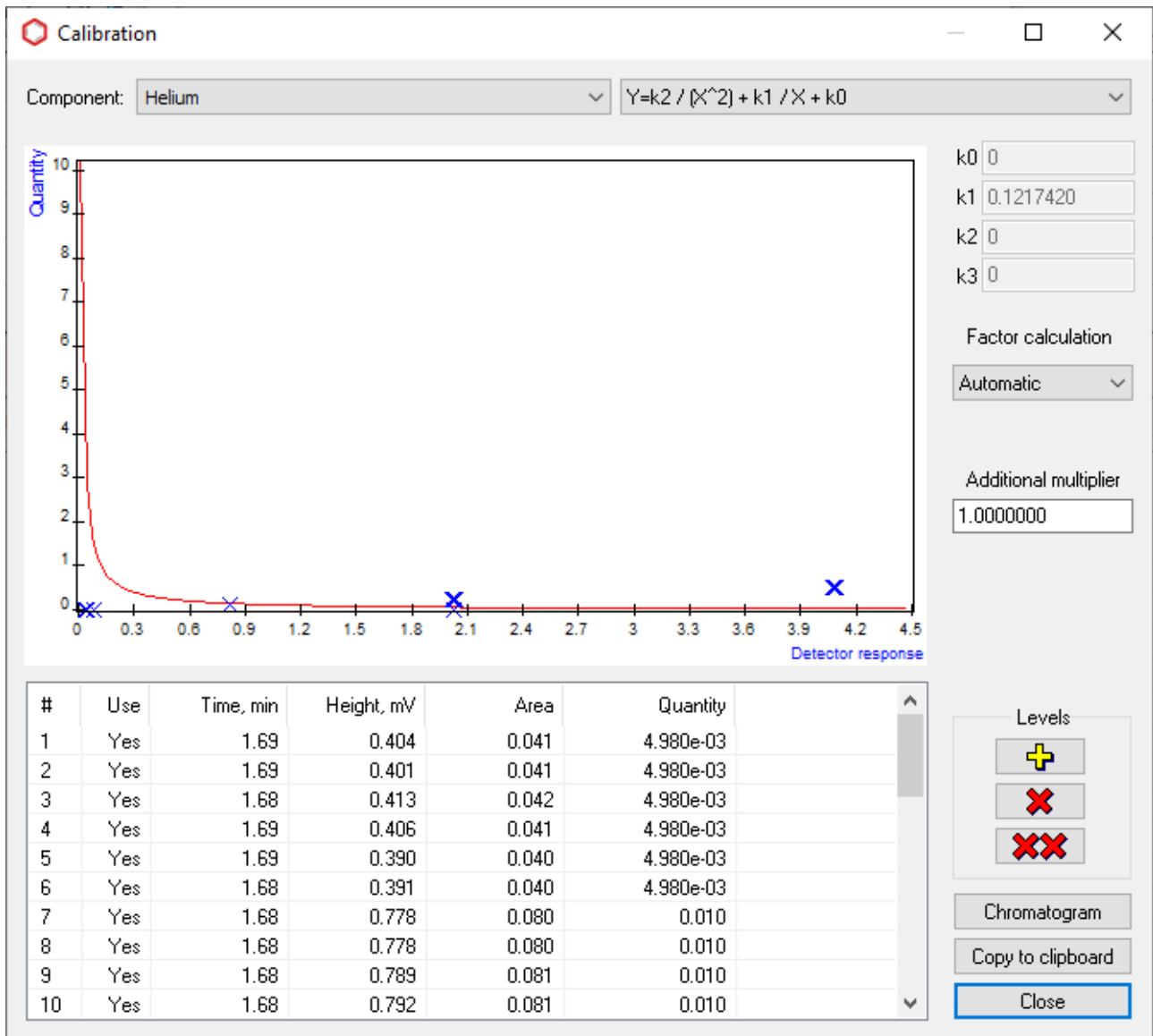



Fig. 59: Calibration

Note: For such methods as *Simple Normalization* and *Internal Standard Model*, the *Calibration* window is unavailable.

1. In the *Calibration* window, add levels (calibration chromatograms):
 - To add a level, click  **Add a calibration level**.
 - To open a chromatogram of the selected level, click **Chromatogram**.
 - To delete the selected level, click  **Delete the selected calibration level**.
-

Note: If you want to exclude a level from the calibration without deleting it, in the table of calibration points, double-click in the relevant box of the *Use* column.

1. (Optional) To copy the entire table of calibration points to the clipboard, click **Copy to Clipboard**.
2. In the *Component* field, select the component for which the calibration is performed from the list.
3. (Optional) For such methods as *Absolute Calibration (Least Squares Method)* and *Internal Standard (by Absolute Coefficients)*, select a calculation formula from the list.
4. In the *Factor calculation* field, select a factor calculation method from the list:
 - Automatic;
 - Manual;
 - Relative.
1. (Optional) If the factor is calculated manually, enter its value in the factor field (for example, k1).
2. (Optional) If the factor is calculated relatively, select an additional component from the list, relative to which the factor will be calculated.
3. In the *Additional multiplier* field, enter the additional multiplier.
4. Click **Close**.
5. Click **OK**.

6.28.2. Calibration Factors Calculating

When creating a method, it is necessary to set calibration factor calculation parameters per channel (Fig. 60).

To configure calculation parameters:

1. In the *Method* menu, select **Chromatogram Method**. The *Method* window opens.
 2. In the *Method* window, in the *Calibration* tab, select the channel tab, for which you want to set parameters.
 3. In the *Calculation method* field, select a calculation method from the list. After the calculation is selected, the *Calibration* button becomes active.
-

Note: For descriptions of standard calculations, see [Sec. 8.6. Standard Method Calculations](#).

1. To exclude unidentified components from the norm, select the **Normalization only for identified** checkbox.
-

Note: The concentration of all components in the norm gives 100%. If you want to ignore

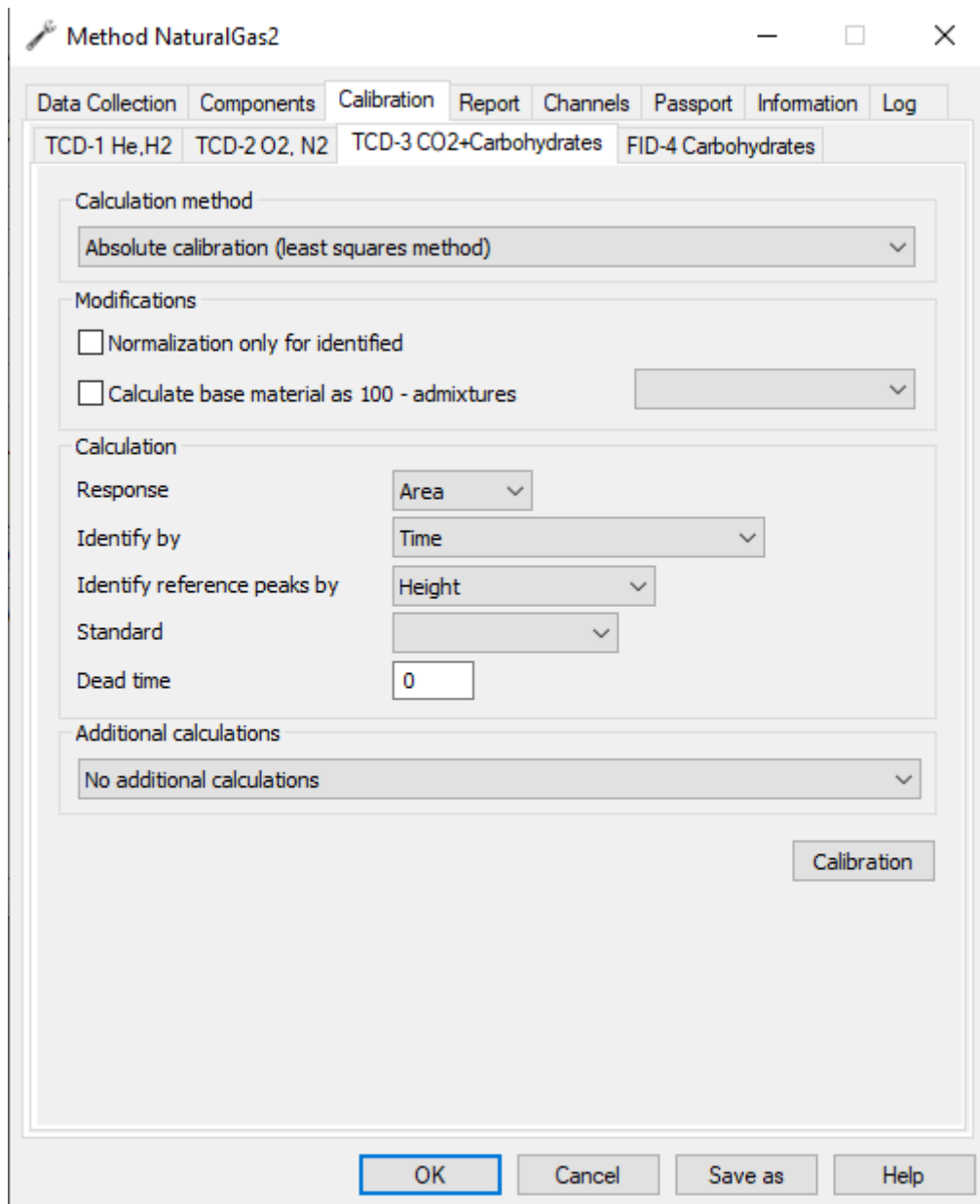

Fig. 60: Method > Calibration

unidentified components when calculating the norm, select this checkbox.

2. To calculate the basic substance residue, select the **Calculate basic substance as 100 - admixtures** checkbox.
3. In the *Response* field, select a response parameter from the list:
 - Height;
 - Area.
1. In the *Identify by* field, select an identification parameter from the list:
 - Time;
 - Linear indices;
 - Logarithmic indices.
1. In the *Identify reference peaks by* field, select a reference peak identification parameter from the list:
 - Height;
 - Area;
 - Time;
 - Number.
1. In the *Standard* field, select a gas standard from the list.
2. In the *Dead time* field, enter the time it takes to go from the column inlet to the detector (dead time).
3. To save the changes, click **OK**.
4. To calibrate the instrument, click **Calibration**. See [Sec. 6.28.1. Plotting a Calibration](#).

6.28.3. Recording Calibration Chromatograms

To apply some methods, it is necessary to plot a calibration. To do this, enable a relevant option in the chromatogram passport. Also, to calibrate the instrument, you may need to name peaks and manually enter their concentration.

1. In the *Chromatogram* menu, click **Passport...**
 2. In the *Sample* section, next to the *Calibration* property, select **Yes** ([Fig. 61](#)).
-
1. To set a component name, in the *Component* column of the peak table, double-click the desired component box. The *Component* window opens.
 2. In the *Component* window, select one of existing names or enter a new one.
 3. Click **OK**.
 4. To enter the concentration manually, in the *Component* column of the peak table, double-click the desired component box.
 5. Enter the concentration value.
 6. Click Enter.

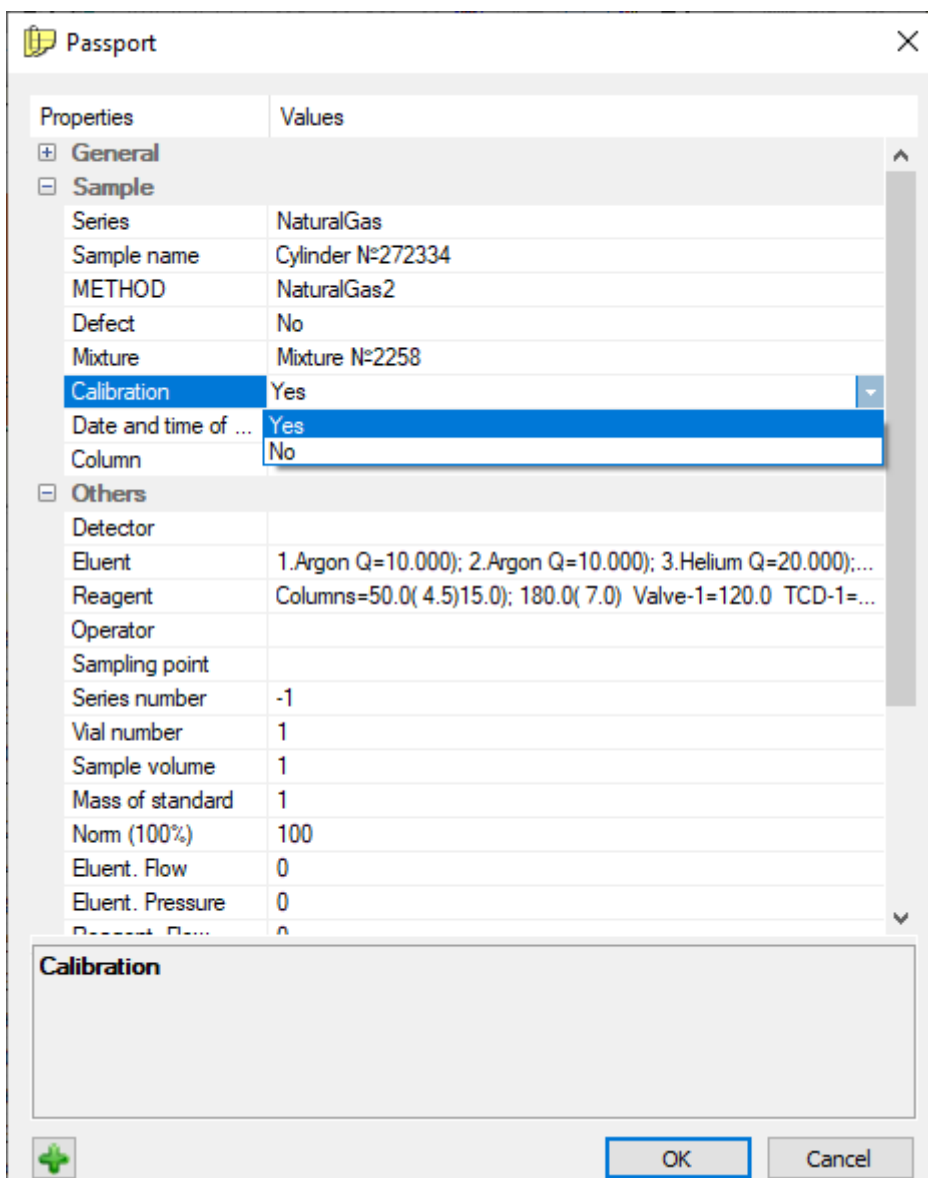

Fig. 61: Calibration Checkbox

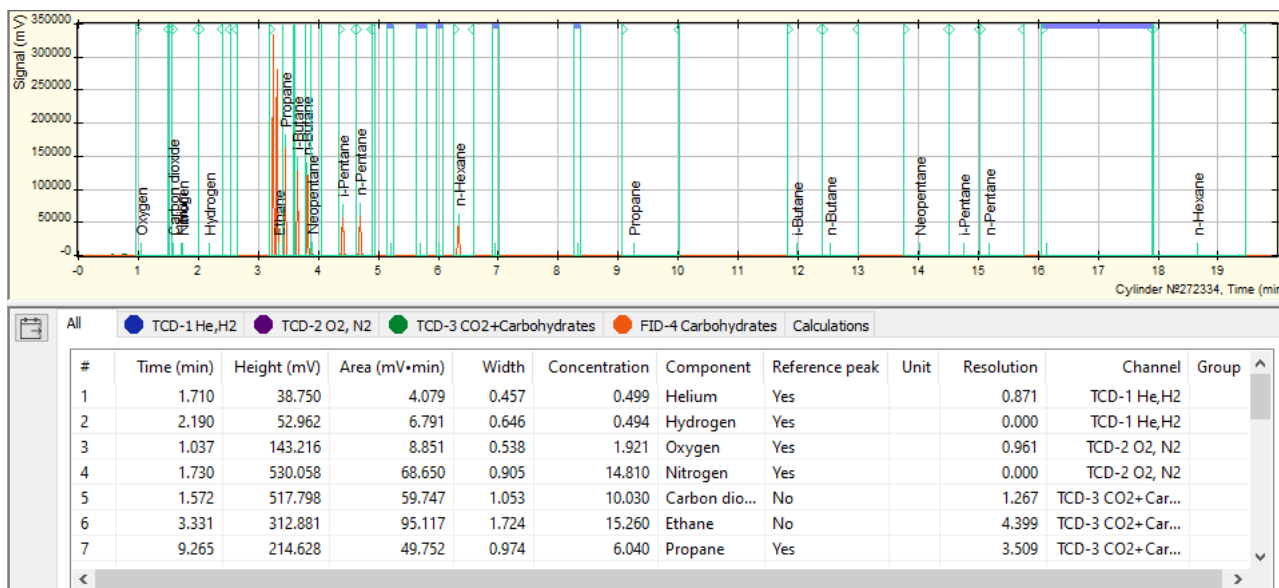

Fig. 62: Chromatogram Window and Peak Table

6.28.4. Determining an Unknown Sample

Concentrations of an unknown (non-calibration) sample are calculated automatically. However, if the *Calibration* checkbox is selected in the chromatogram passport, no automatic concentration calculation is performed. In new analyses the *Calibration* checkbox is selected by default based on the previous analysis performed using this method.

The method is selected once. Subsequent analyses for this channel are linked to the selected method. For example, selecting a method once, you can run analyses using this method by pressing **Start/Stop** on the chromatograph front panel (Fig. 63).



Fig. 63: Chromatograph front panel

If you need manual recalculation of concentrations, click **Recalculate**.

6.29. Database

The database (DB) is a function to store data on analyses, components, calibration mixtures, operators and sampling places.

The *Database* menu contains links to plugins that allow to manage information in the database:

- Calibration mixtures – editor of calibration mixtures;
- Analyses – table of measurements (chromatograms);
- Sampling places – table of sampling places;
- Sampling points – table of sampling points;
- Operators – list of analysts;
- Components – guide on components;
- Columns – guide on chromatographic columns.

The menu also includes database management functions:

- DB compression – when data are updated, the database file size grows, and deletion results in empty memory cells that are not returned to the operating system, thus leading to fragmentation. The compression restores storages by writing the contents of all tables to a new database file. This process frees up unused space and ensures that all tables and indices are stored continuously.
- Scan – updates chromatogram information in the database.

For more details on how to use the database, see [Sec. 6.29.1. Using the Database](#).

6.29.1. Using the Database

Using the database includes database scanning (updating a chromatogram catalog), database compression and database item data editing.

- To update the chromatogram catalog:

1. In the *Database* menu, select **Service > Scan**. The *Chromatogram Registry Scanning* window opens.
2. In the opened window, click **Search**. When the search ends, information is displayed about the found, added and updated chromatograms, as well as errors that have occurred.

- To compress a database, in the *Database* menu, select **Service > DB Compression**.

There are several plugins to edit data on database items. Below is a description of how to use each of them:

6.29.1.1 Editing the Sampling Places

To manage data on sampling places, do the following:

1. In the *Database* menu, select **Sampling Places**. The *Sampling Places* window opens.
2. Select a sampling place entry:
 - To edit an existing entry, double-click it or select it and click **Edit**. A parameter editing window opens.
 - To add a new entry, click **Add**. A parameter editing window opens.
 - To delete an entry, select it and then click **Delete**.
1. In the *Name* field, enter the sampling place name.
2. Click **OK**.

6.29.1.2 Editing the Sampling Points





To manage data on sampling points, do the following:



1. In the *Database* menu, select **Sampling Points**. The *Sampling Points* window opens.
2. Select a sampling point entry:
 - To edit an existing entry, double-click it or select it and click **Edit**. A parameter editing window opens.
 - To add a new entry, click **Add**. A parameter editing window opens.
 - To delete an entry, select it and click **Delete**.
1. In the parameter editing window, in the *Sampling place* field, select the sampling place.
2. In the *Sampling point* field, enter the name of the sampling point.
3. Click **OK**.

6.29.1.3 Editing the Calibration Mixtures





To work with data on calibration mixtures, the software has a *Calibration Mixture Editor* plug-in. The mixture table displays such data as mixture name, cylinder, passport, release date, and expiration date.

You can perform the following actions:

- To select an existing mixture, select it in the mixture table.
- To edit the selected mixture, in the mixture table, double-click it or click  **Open Mixture Editor**. The *Mixture* window opens.
- To add a new mixture, click  **Add Mixture**. The new mixture is displayed in the mixture table.
- To delete the selected mixture, click  **Delete the Selected Mixture**.
- To delete all mixtures, click  **Delete All Mixtures**.

- To update the table, click  **Reload Mixtures**.
- To export mixtures to an XML file, click  **Export mixtures to XML**.
- To import mixtures from an XML file, click  **Import mixtures from XML**.

When editing a mixture, the *Mixture* window opens. In this window, take the following actions:

1. In the *Name* field, enter the mixture name (number).
2. In the *Cylinder* field, enter the cylinder number.
3. In the *Passport* field, enter the passport number.
4. In the *Released* field, enter the release date in the DD.MM.YYYY format. You can also select a date in the calendar window, for this, click  **Calendar**.
5. In the *Expires* field, enter the expiration date in the DD.MM.YYYY format. You can also select a date in the calendar window, for this, click  **Calendar**.
6. Choose an action:
 - To select an existing component, select it in the component table.
 - To add a component, click  **Add Component**.
 - To delete the selected component, click  **Delete the Selected Components**.
 - To delete all components, click  **Delete All Components**.
 1. To name a component, in the *Component* column in the component table, double-click the relevant box and enter the name.
 2. To set a maximum component concentration, in the *Concentration* column in the component table, double-click the relevant box and enter the concentration value.
 3. To set an error, in the *Uncertainty* column in the component table, double-click the relevant box and enter the error value.
 4. To save the changes, click **Save**.
 5. Click **OK**.

6.29.1.4 Editing the Operator Data





To manage the operator data, do the following:

1. In the *Database* menu, select **Operators**. The *Operators* window opens.
2. Select an entry about the operator:
 - To edit an existing entry, double-click it or select it and click **Edit**. A parameter editing window opens.
 - To add a new entry, click **Add**. A parameter editing window opens.
 - To delete an entry, select it and then click **Delete**.
 1. In the parameter editing window, in the *Name* field, enter the operator's name.
 2. Click **OK**.

6.29.1.5 Editing the Analysis Data

To manage data on analyses:

1. In the *Database* menu, select **Analyses**. The *Measurements* window opens.
2. Select an entry about the analysis:
 - To edit an existing entry, double-click it or select it and click **Edit**. A parameter editing window opens.
 - To add a new entry, click **Add**. A parameter editing window opens.
 - To delete an entry, select it and then click **Delete**.
 1. In the parameter editing window, in the *Series* field, enter the series.
 2. In the *Date/Time of Analysis* field, enter the analysis date and time in the DD.MM.YYYY

- HH:MM:SS format. You can also select a date in the calendar, for this, click  **Calendar**.
3. In the *Calibration* field, select an option from the list whether it is a calibration chromatogram or not:
 - Yes;
 - No.
 1. In the *File name* field, enter a path to the chromatogram file.
 2. In the *Hidden* field, select an option from the list whether it is a hidden chromatogram or not:
 - Yes;
 - No.
 1. In the *Removed* field, select an option from the list whether the chromatogram is removed or not:
 - Yes;
 - No.
 1. In the *Sampling Place* field, select a sampling place from the list. To navigate to the sampling places editor, click  **Ellipsis**.
 2. In the *Sampling Point* field, select a sampling point from the list. To navigate to the sampling point editor, click  **Ellipsis**.
 3. In the *Sampling Date/Time* field, enter the sampling date and time in the DD.MM.YYYY HH:MM:SS format. You can also select a date in the calendar, for this, click  **Calendar**.
 4. In the *Sample* field, enter the sample information (number).
 5. In the *Operator* field, select an operator from the list. To navigate to the operator editor, click  **Ellipsis**.
 6. In the *Method* field, enter the method name.
 7. In the *Duration* field, enter the chromatogram recording duration (in minutes).
 8. In the *Parameters 1* field, enter the parameters of components, concentrations and pressures.
 9. In the *Parameters 2* field, enter the parameters of column, valve and detector.
 10. In the *Mixture* field, enter the mixture information (number).
 11. In the *Atmospheric Pressure (kPa)* field, enter the atmospheric pressure value (in kPa).
 12. In the *Ambient Temperature (°C)* field, enter the ambient temperature (in °C).
 13. In the *Notes* field, enter a comment.
 14. Click **OK**.



6.29.1.6 Editing the Measurement Series Data

To manage the measurement series data:

1. In the *Database* menu, select **Measurement Series**. The *Measurement Series* window opens.
2. Select an entry about the series:
 - To edit an existing entry, double-click it or select it and click **Edit**. A parameter editing window opens.
 - To add a new entry, click **Add**. A parameter editing window opens.
 - To delete an entry, select it and then click **Delete**.
1. In the parameter editing window, in the *Name* field, enter the series name.
2. Click **OK**.

6.29.1.7 Editing the Column Data

Column data are edited using the *Database* module or the chromatogram passport. To manage the column data:

1. Open the column data management window:
 - In the *Database* menu, select **Columns**. The *Columns* window opens.
 - On the control panel, click  **Chromatogram Passport**, then in the *Passport* window in the *Column* field, click  **Parameters**. The *Column* window opens.

Note: The column data management windows vary depending on whether the *Database* module or the chromatogram passport is used for editing.

1. (Optional) When the *Database* module is used for editing, in the *Columns* window select an action:
 - To edit an existing entry, double-click it or select it and click **Edit**. A parameter editing window opens.
 - To add a new entry, click **Add**. A parameter editing window opens.
 - To delete an entry, select it and then click **Delete**.
1. In the *Name* field, enter the column name.
2. In the *Manufacturer* field, enter the column manufacturer.
3. In the *Registry Number* field, enter the registry number.
4. In the *Serial Number* field, enter the serial number.
5. In the *Inner Diameter (mm)* field, enter the inner diameter value (in mm).
6. In the *Length (m)* field, enter the column length (in m).
7. In the *Type* field, select the column type from the list:
 - Capillary;
 - Packed;
 - Micropacked;
 - HPLC.

Note: Other parameters vary depending on the selected column type. Film thickness is indicated for a capillary column; fraction range for a packed or micropacked column; grain size for an HPLC column. Carrier, phase and quantity parameters for an HPLC column are not entered.

1. In the *Carrier* field, enter the carrier properties.
2. In the *Phase* field, enter the phase properties.
3. In the *Quantity (%)* field, enter the mass content percentage of stationary liquid phase (SLP) applied to the column solid support (SS).
4. In the *Units* field, select units from the list:
 - mm;
 - mesh.
1. In the *Fraction from* field, enter the minimum diameter of sorbent particles (in mm or mesh).
2. In the *Fraction up to* field, enter the maximum diameter of sorbent particles (in mm or mesh).
3. In the *Grain size* field, enter the sorbent particle size (in μm).
4. In the *Film thickness* field, enter the thickness of SLP applied to the CC walls (in μm).
5. Click **OK**.

6.29.1.8 Editing the Component Data

To manage the component data, do the following:

1. In the *Database* menu, select **Components**. The *Components* window opens.
2. Select an entry about the component:
 - To edit an existing entry, double-click it or select it and click **Edit**. A parameter editing window opens.
 - To add a new entry, click **Add**. A parameter editing window opens.
 - To delete an entry, select it and then click **Delete**.
1. In the parameter editing window, in the *Id* field, enter the identifier.
2. In the *Name* field, enter the component name.
3. Click **OK**.

6.30. Instrument Verification

The instrument verification module in Chromos SW calculates such metrological characteristics as relative standard deviation (RSD) of height, area and peak exit time, fluctuation noise, baseline drift and detection limit. After calculation, the module generates a verification report.

To carry out a verification, you need to load 10 chromatograms and specify the instrument parameters. Some field values vary depending on the selected parameters.

- Since instruments manufactured in different years meet different Technical Specifications (TU) and were improved over the time, the list of detectors and detection limits for the instrument may differ. In Chromos SW, you may select the TU, according to which the instrument was released. The TU are indicated in the *Standards* field (Fig. 64).

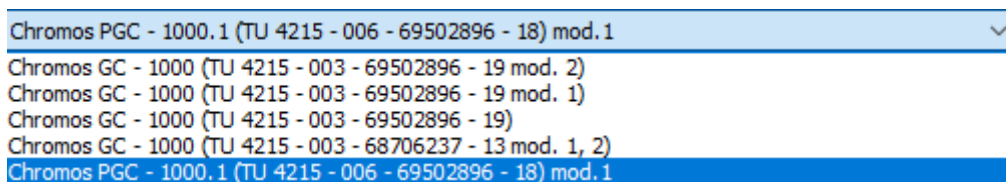

Fig. 64: TU Selection

It is necessary to select the standards corresponding to the test chromatograph TU (they are indicated on the tag with the chromatograph serial number). Depending on the selected standards, values in the *Detector* field are displayed (Fig. 65).

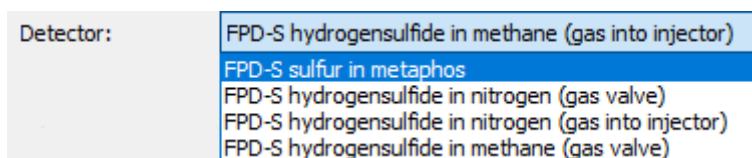

Fig. 65: Detector Selection

- In loaded chromatograms, the name of the component used to calculate the RSD and the detection limit shall match the component name indicated in the *Detector* field. If the component names are mismatched, the chromatogram table has dashes in the columns (Fig. 66).
- When selecting concentration detectors, the *Carrier Gas Flow Rate* field becomes available, in which you need to indicate the carrier gas flow rate value as specified in the *Configuration* window. When streamline detectors are selected, this field is unavailable. When a liquid chromatograph is selected, this field is replaced by the *Eluent Flow Rate* field.

File	Sample	Time	Height	Area	Concentration
NaturalGas_030921_091801.xstg	Cylinder №...	-	-	-	-

Fig. 66: Mismatched Components

- When the detector and the test component are specified, the *Sampler* field is displayed correctly. For gas samples, it is a valve or a split valve; for liquid samples, it is an injector or a capillary injector. It is necessary to select the sampling device that is involved in this channel verification. When selecting a valve as a sampling device, it is necessary to specify the valve temperature and pressure in the valve sampling loop (for non-thermostated valves, room temperature is indicated). For a split valve and a capillary injector, a sample split ratio is additionally indicated – either calculated using a gas calculator, or set in the *Configuration* window when the GFR is operated in the sample discharge line in the *Split Ratio* mode.
- For any detector and sampling device, the *Concentration* and *Sample Volume* fields shall be filled in.
- To calculate fluctuation noise and drift, a zero chromatogram shall be selected.
- The *Instrument Number*, *Channel Number* and *Detector Number* fields shall be completed.
- Relevant data from the chromatogram passport shall be imported into the *Column*, *Gas Parameters* and *Temperature Parameters* fields.

After all the necessary fields are filled in, the program will automatically calculate metrological characteristics. If all the metrological characteristics meet the standards, then *Yes* is displayed in the results table in the *Verification Passed* column (Fig. 67).

Result	Real	Norm	Verification successful
RSD by time	0.338%	0,01	Yes
RSD by area	0.695%	0,02	Yes
RSD by height	0.996%	not standardized	Yes
Noise	3.917e-007 V	9.000e-006 V	Yes
Drift	1.253e-006 V/h	1.000e-004 V/h	Yes
Limit of detection	2.885e-101 g/cm3	1.000e-009 g/cm3	Yes

Fig. 67: Verification Passed

Afterwards, the program can generate a verification report and send it to print.

Note: If at least one parameter fails to meet the standards, no report is generated, and the program issues a message that the verification has failed.

For more details on how to fill in the fields during verification, see [Sec. 6.30.1. Verifying the Instrument](#).

6.30.1. Verifying the Instrument

To carry out the instrument verification, you need to load chromatograms for calculations and specify the instrument parameters. Below is a procedure for filling in the required fields.

For more details, see [Sec. 6.30. Instrument Verification](#).

1. In the *Data* menu, select **Verification**. The *Verification* window opens.
2. In the *Verification* window, select chromatograms for calculations:
 - To add a chromatogram, click **Add**. In the opened window, select the desired chromatogram and click **OK**.
 - To delete a chromatogram from the table, select it and click **Delete**.
 - To delete all chromatograms from the table, click **Delete All**.
 - To open a chromatogram, select it and click **Open**.
 - To refresh the list, click **Refresh**.
 - To select a zero chromatogram (to calculate fluctuation noise and drift), select the chromatogram in the chromatogram table and click **Baseline**. Path to the baseline (zero) chromatogram is displayed in the *Baseline* field.
1. In the *Instrument Number* field, enter the instrument number.
2. In the *Channel Number* field, enter the channel number.
3. In the *Detector Number* field, enter the detector number.
4. In the *Standards* field, select the standards, according to which the test instrument was released from the list (see the chromatograph Technical Specifications in the serial number tag).
5. In the *Detector* field, select the detector type from the list.
6. In the *Sampler* field, select the sampler type from the list.
7. In the *Mixture* field, select a mixture from the list.
8. In the *Concentration* field, enter the component concentration (depending on the detector).
9. In the *Sample Volume* field, enter the sample volume.
10. In the *Carrier Gas Flow Rate/Eluent Flow Rate* field, enter the carrier gas/eluent flow rate.
11. In the *Sample Split Factor* field, enter the sample split ratio (for a split valve and a capillary injector).
12. In the *Valve Temperature/Syringe Temperature* field, enter the valve/syringe temperature value (in °C).
13. In the *Valve Dose Pressure/Syringe Pressure* field, enter the pressure value (in mm Hg).
14. In the *Mains Voltage* field, enter the mains voltage value (in V).
15. In the *Mains Frequency* field, enter the mains frequency value (in Hz).
16. In the *Atmospheric Pressure* field, enter the atmospheric pressure value (in kPa).
17. In the *Ambient Temperature* field, enter the ambient temperature (in °C).
18. In the *Relative Air Humidity* field, enter the relative air humidity value (in %).
19. Click **Report**.

If verification has been passed successfully, the report is generated and sent for printing.

6.31. Statistics

The statistics module ([Fig. 68](#)) in Chromos SW is designed to calculate metrological characteristics of components – average values and relative standard deviations (RSD). Such calculation is normally required for initial or periodic state instrument verification. Based on statistical check results, you can generate a report and export it to .txt, .odt, .html, and .csv formats.

The following data are added to the report:

- Component;
- Channel;

UUID	Sample	Mixture	Time, min	Type	Method	File name
9b3...	Cylinder №272...	Mixture №2258	03.09.2021 9:18:01	Calibration	NaturalG...	NaturalGas_030921_091...

Component	Cha...	Mixture	Amount	Average tim...	Time StdDev, %	Average hei...	Height StdDev, %
Helium	1	Mixture №2...	1	1.710	—	38.750	
Hydrogen	1	Mixture №2...	1	2.190	—	52.962	
Oxygen	2	Mixture №2...	1	1.037	—	143.216	
Nitrogen	2	Mixture №2...	1	1.730	—	530.058	
Carbon di...	3	Mixture №2...	1	1.572	—	517.798	
Ethane	3	Mixture №2...	1	3.331	—	312.881	
Propane	3	Mixture №2...	1	9.265	—	214.628	
i-Butane	3	Mixture №2...	1	11.977	—	188.121	
n-Butane	3	Mixture №2...	1	12.525	—	205.453	
Neopentane	3	Mixture №2...	1	14.035	—	3.038	
i-Pentane	3	Mixture №2...	1	14.751	—	106.923	

Fig. 68: Statistics Window





- Mixture;
- Quantity;
- Average Time (min);
- Time RSD (%);
- Average Peak Height (mV);
- Peak Height RSD (%);
- Average Area (mV*min);
- Area RSD (%);
- Concentration RSD (%).

More details on how to use the statistics module, see [Sec. 6.31.1. Using Statistical Data](#).

6.31.1. Using Statistical Data

To obtain statistical data, do the following:

1. In the *Data*, select **Calculations > Statistics**. The *Statistics* window opens.
2. In the *Statistics* window, specify chromatograms for subsequent analysis:
 - To add chromatograms for analysis, click **Add Chromatograms** and select the desired chromatogram in the opened window.
 - To select a chromatogram for subsequent analysis, check the box next to the desired chromatogram.
 - To delete a chromatogram, select it and click **Delete the Selected Chromatograms**.
 - To delete all chromatograms, click **Delete All Chromatograms**.
 - To open a chromatogram, select it and click **Open Chromatogram**.
 - To refresh the chromatogram data, click **Reread Chromatograms**.

1. To select a method to calculate the relative standard deviation (RSD), click  **Settings** and select the method:
 - Single measurements $/(n-1)$
 - Arithmetic mean $/n*(n-1)$
1. To group components by mixtures, click  **Settings** and select **Group by Mixtures**.
2. To select a component for calculation, select the checkbox next to the desired component.
3. To recalculate the result of statistical calculations, click  **Recalculate**.
4. To export a report, click  **Export Calculation Result** and select the format:
 - ODT – Open Document format;
 - TXT – ordinary text file format;
 - HTML – Web page format;
 - CSV – text table format;
 - Copy – copy the report to the clipboard.
1. In the opened window, select a file folder and click **OK**.

7. Specific Devices Operating Procedures

This section describes some specific procedures for using and setting software-compatible devices.

7.1. Chromos GC-1000

This section describes the settings of the Chromos GC-1000.

7.1.1. General

In the *General* tab (Fig. 69) you can set the temperature of temperature-controlled objects, adjust the temperature program of columns and specify operating parameters for gas flow regulators. This tab also displays information about the instrument readiness for analysis. To select general settings, navigate to *Chromos GC-1000.1 Configuration > General* and do the following:

1. In the *Set* fields of the *Temperatures (°C)* section, enter a temperature value (in °C) for each temperature zone. The measured temperatures are displayed in the *Measured* fields.

Note: For information on temperature zones, see [Sec. 8.9. Temperature Zones](#).

1. In the *Column temperature program* section, specify data on the column oven temperature program (fields are to be filled for each stage):
 - In the °C field, enter initial temperature of the stage (in °C).
 - In the *min* field, enter stage duration (in min).
 - In the °C/min field, enter the rate of temperature increase to the next stage level (in °C/min).

Note: If the temperature increase rate is set to zero, the cycle is near completion and the last temperature is maintained until the end of analysis.

1. In the *Gas flow regulators* section, specify data on flow rates and types of carrier gas, as well as hydrogen and air:
 - To select the type of carrier gas or to program the modes of gas flow regulators (GFRs), select the channel (in the figure below: 1. Nitrogen). For details on how to configure GFR modes, see [Sec. 6.7.4. Configuring Gas Flow Regulators \(GFRs\)](#).
 - In the *Set* fields, enter the flow rate (in cm³/min) or another value programmed in the mode. The measured values are displayed in the *Measured* fields.
1. To start cooling, click **Cooling**.
2. To save the settings, click **Apply**.

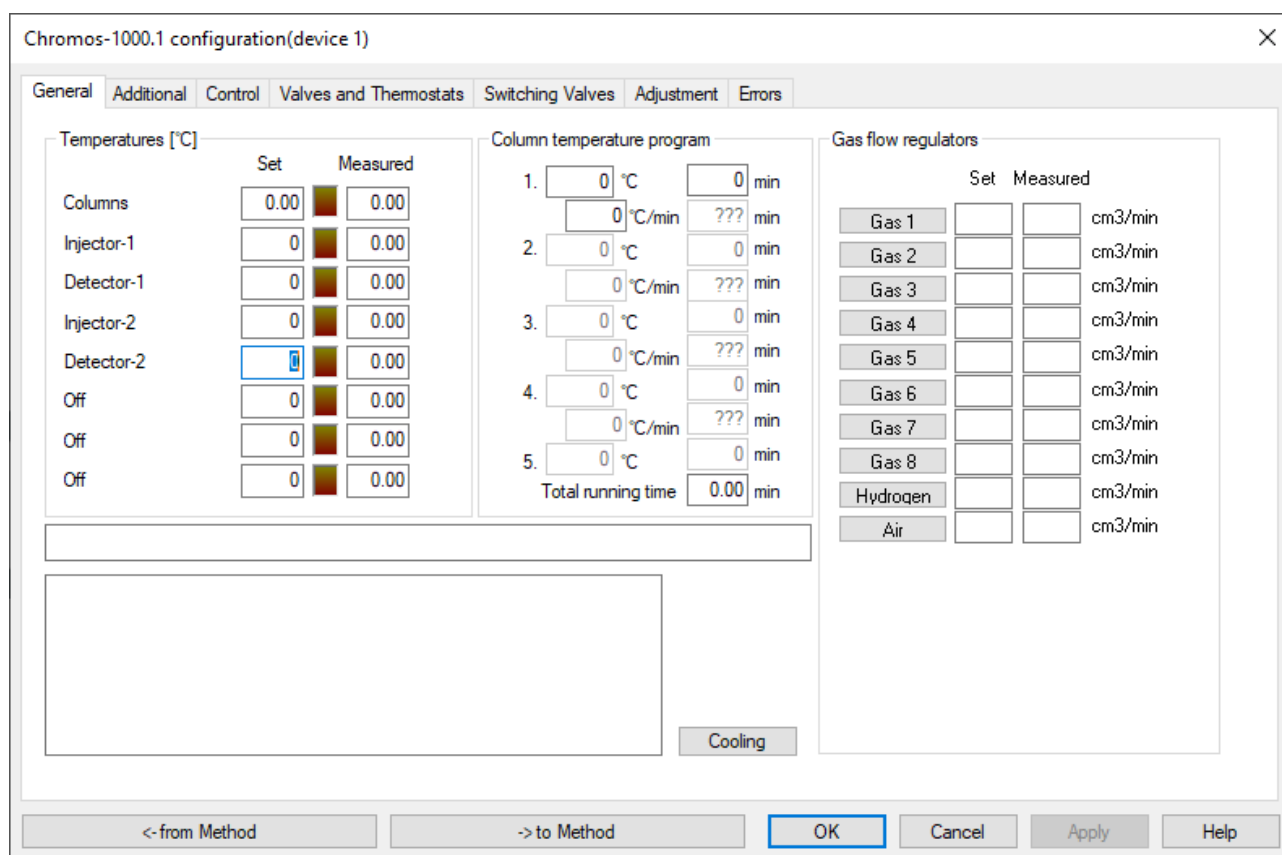

Fig. 69: Chromos GC-1000.1 Configuration > General

7.1.2. Additional

The *Additional* tab (Fig. 70) contains a list of connected detector modules, overheat control values, permissible deviations and ignition parameters. In the *Additional* tab, you can set temperature tolerances of temperature-controlled objects, gas flow rate tolerances, flame ignition parameters of FID, FTD, FPD, as well as buttons to start recording on additional channels. To select additional parameters, navigate to *Chromos GC-1000.1 Configuration > Additional* and do the following:

1. Enable the required options:
 - To view modules in the instrument, click **CU**.
 - Not to wait for the temperature program end, select the **Do not wait for temperature program end** checkbox.
 - To close the oven exhaust vent, select the **Close the oven exhaust vent** checkbox.
 - To invert the detector signal for a relevant detector, select the **Invert Det.** checkbox.
1. Adjust the cooling fan operating mode:
 - To start it in silent mode, select the **Silent mode** checkbox.
 - To run it at full power, select the **Fast fan mode** checkbox.
1. In the *Ready start check* field, enter the waiting time from the moment the instrument reaches the mode to the start of analysis (in seconds).
2. In the *Consumption* section, configure the economy parameters:
 - In the *Delay before ready* field, enter the delay before ready state (in seconds).
 - In the *Gas flow rate* field, enter the gas flow rate in economy mode (in cm3/min).
1. In the *Ignition parameters* section, configure the ignition parameters:
 - In the *Flame detection level* field, enter the flame detection level for each detector (in mV, see [Sec. 8.8.22. Flame Detection Level](#)).

- In the *Ignition attempts* field, enter the number of attempts.
 - To control the ignition manually, click **Manual ignition**.
1. In the *Temperature zone parameters* section, configure the temperature zone parameters for temperature-controlled objects:
 - In the *Max. temp.* field, enter the maximum permitted temperature for the object used (in °C).
 - In the *Tolerance* field, enter permissible deviations of measured temperatures from setpoints (in °C).
 1. In the *Gas tolerance* section, set permissible deviations of measured values from setpoints for the gases used:
 - In the *Flow rate* field, enter the permissible flow rate deviation.
 - In the *Pressure* field, enter the permissible pressure deviation.
 1. In the *Additional recording channels* section, select the required parameter for each additional channel (see [Sec. 8.5. Additional Recording Channels](#)).
 2. To save the settings, click **Apply**.

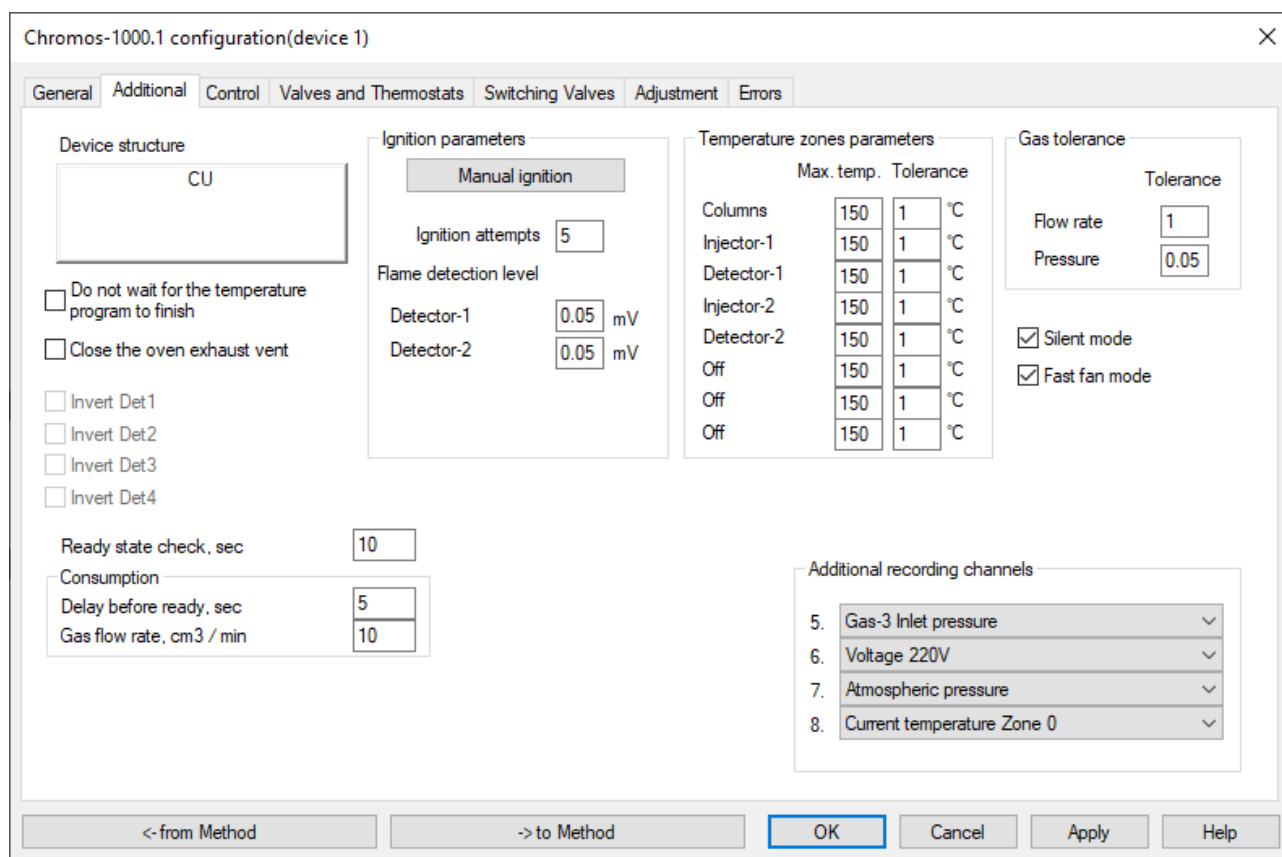

Fig. 70: Chromos GC-1000.1 Configuration > Additional

7.1.3. Control

The *Control* tab (Fig. 71) is designed to monitor GFR status, detector signal level, damper position, mains voltage, and the presence of flame in detectors. To obtain information about the instrument operation, navigate to *Chromos GC-1000.1 Configuration > Control*.

- The *GFR* section displays data on GFR operation:
 - Flow rate, in cm³/min – carrier gas flow rate;
 - Pin, in kgf/cm² – inlet pressure;
 - Pout, in kgf/cm² – outlet pressure;

- Valve voltage, in V (0–10) – voltage in GFR valve.
- The *Detector response, mV* section displays the detector signal value (in mV) for each channel. A baseline signal is obtained from a blank run.
- The *Vent* field displays the position of oven exhaust vent and the percentage of their opening.
- The *220 V* field displays the measured voltage value.
- The *Detectors power supply* field displays the power supply value (300 V) of detectors.
- The *Buttons* field displays the indicators of analysis and start buttons on the instrument front panel.
- The *Flame* field displays the current flame status.

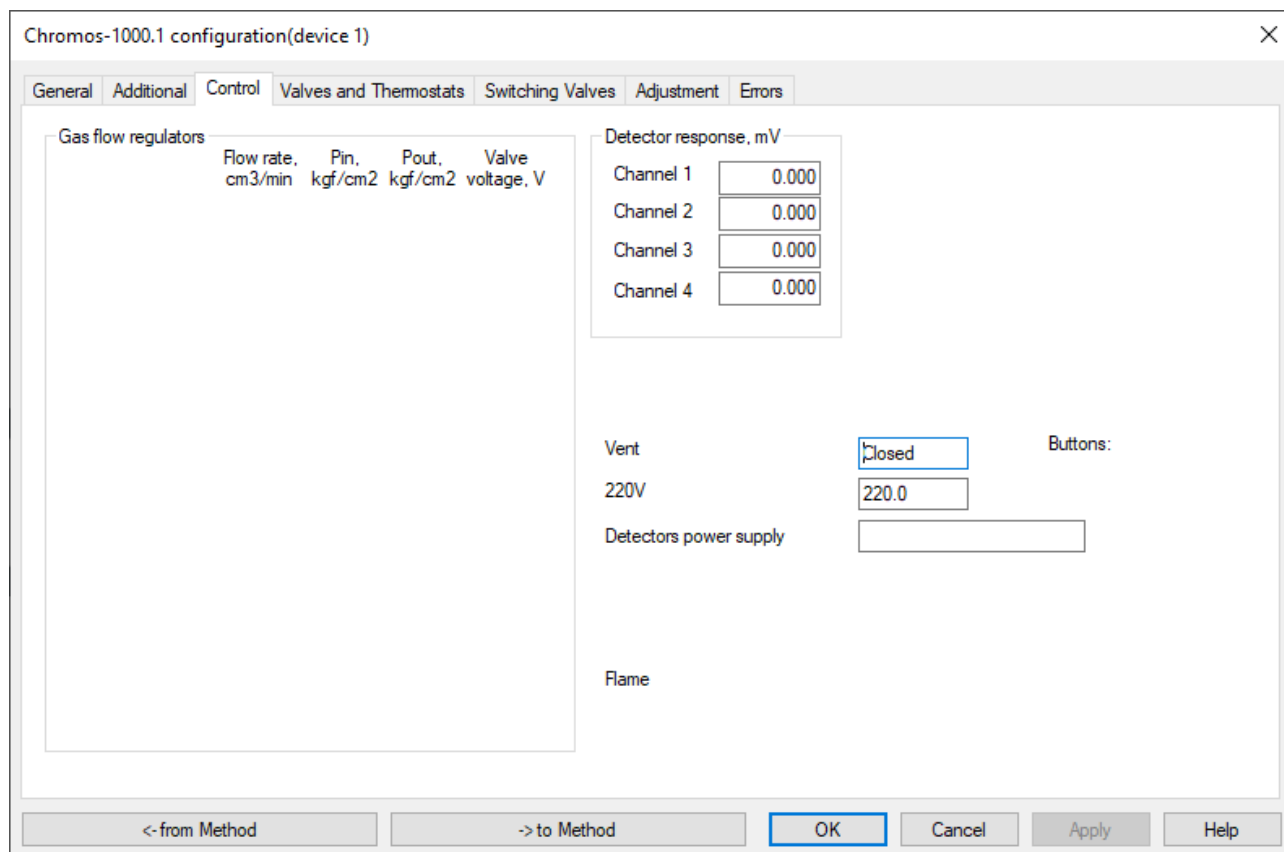

Fig. 71: Chromos GC-1000.1 Configuration > Control

7.1.4. Valves and Thermostats

In the *Valves and Thermostats* tab (Fig. 72), you can configure injection valves with automatic electric drive, if the instrument has any. To set valve parameters, navigate to *Chromos GC-1000.1 Configuration > Valves and Thermostats* and do the following:

1. In the *Operating Mode* list, select the type of valve.
2. In the *Launch with channel* list, select the channel button that starts the chromatogram recording simultaneously with the valve operation.
3. (For switching valves) In the *Initial state* list, select the initial valve position at the time the chromatogram is recorded:
 - 1 – open;
 - 2 – closed.
1. (For switching valves) In *Time 1* and *Time 2* fields, enter the time (in minutes) after which the valve will switch to position 1 or 2, respectively.
2. When connecting boards of additional temperature zones, in the *Temperature zones (optional)*

section, set the following parameters:

- In the *Set* field, enter a temperature value (in °C) for each temperature zone. The measured value is displayed in the *Measured* field.
- In the *Protection* field, enter the maximum temperature value (protection temperature, in °C).
- The *Tolerance* field displays the instrument readiness status.

Note: For information on temperature zones, see [Sec. 8.9. Temperature Zones](#).

1. In the *Programmable injectors* section, set temperature parameters of programmable injectors:
 - In the *Set* field, enter a temperature value (in °C) for each injector. The measured value is displayed in the *Measured* field.
 - In the *Tolerance* field, enter the permissible deviation.
 - In the *Launch with Channel* list, select the channel which the injector should start with.
 - To use the temperature program, click *Temp. program*. The *Injector Temperature Program* window opens.
1. In the *Injector Temperature Program* window, specify data on the injector oven temperature program (fields are to be filled for each stage):
 - In the °C field, enter initial temperature of the stage (in °C).
 - In the *min* field, enter stage duration (in min).
 - In the °C/*min* field, enter the rate of temperature increase to the next stage level (in °C/min).
 - Click **Save**.
1. To save the settings, click **Apply**.

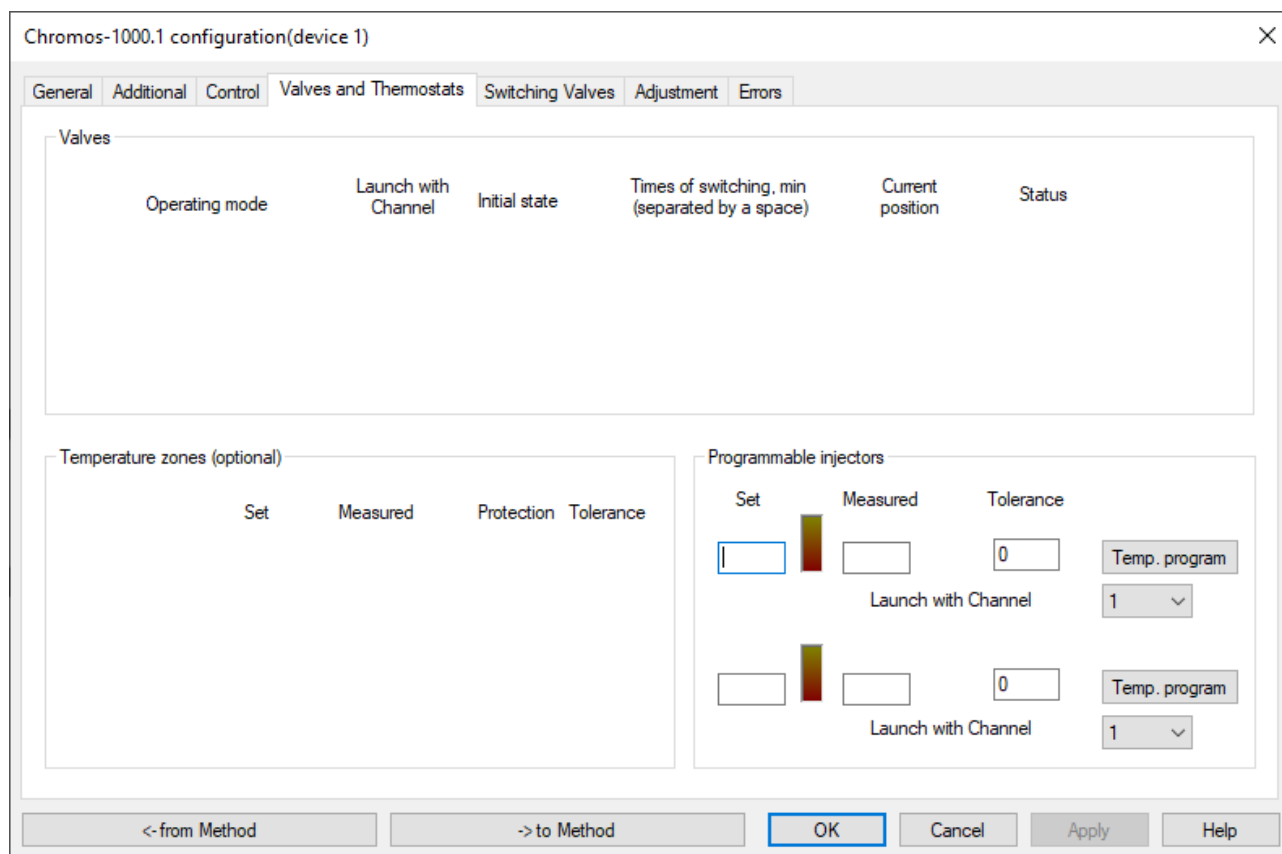

Fig. 72: Chromos GC-1000.1 Configuration > Valves and Thermostats

7.1.5. Switching Valves

In the *Switching Valves* tab (Fig. 73), you can configure the starting position and switching times of valves during the analysis. To configure the valves, navigate to *Chromos GC-1000.1 Configuration > Switching Valves* and do the following:

1. In the *Starting position* field, select the starting position of the valve.
 2. In the *Start with Channel* field, enter the number of the channel, which the valve should start with. The valve status is displayed in the *Current state* field.
 3. In the *Times of switching* field, enter the valve switching time (in minutes):
 - Decimal Symbol: dot.
 - Switching time divider: space, line break or /, |, ;.
1. To save the settings, click **Apply**.

Fig. 73: *Chromos GC-1000.1 Configuration > Switching Valves*

7.1.6. Adjustment

In the *Adjustment* tab (Fig. 74), you can configure PID coefficients of temperature zones and all modules in the chromatograph. For more details on adjustment, see [Sec. 6.8. Adjusting the Instrument](#).

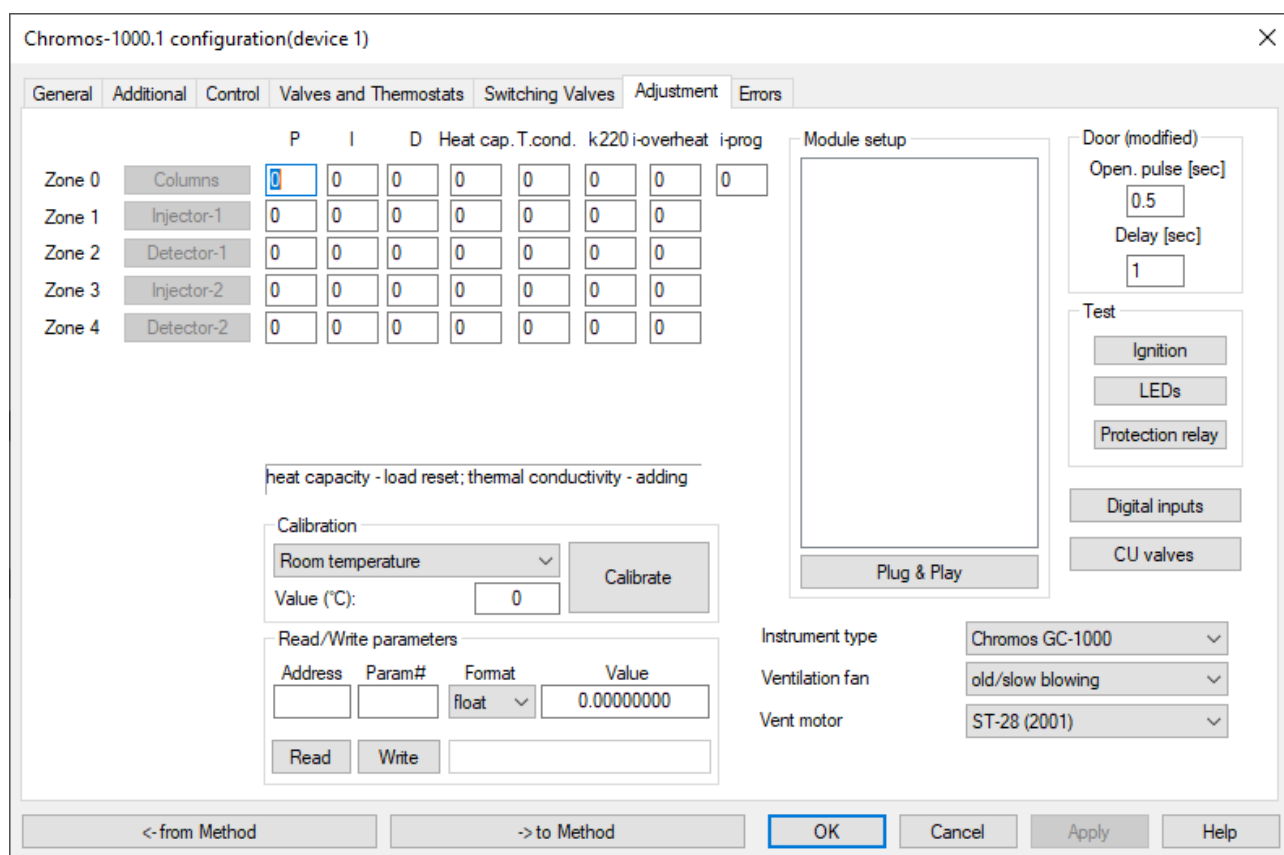

Fig. 74: Chromos GC-1000.1 Configuration > Adjustment

7.1.7. Errors

To view error messages, navigate to *Chromos GC-1000.1 Configuration > Errors* (Fig. 75).

To save the settings, click **OK** or **Apply**.

7.2. SPF-05

In the *SPF-05 Configuration* window (Fig. 76), you can set the following parameters:

1. In the *Wavelength* field, enter the wavelength value (in nm).
2. In the *Split Ratio* field, enter the split ratio value.
3. To save, click **OK** or **Apply**.

7.3. Chromos ADC-2M

The *ADC-2M Configuration* window (Fig. 77) displays settings and indicators. In the *Status* section, the color indicators show the status of device connection and data exchange with the device: the green indicator means the device is ready to start analysis, and the red indicator means it is not ready. Signals from each channel are displayed at the bottom (in mV).

1. To invert a signal from a channel, in the *Invert signal* section, check the box next to that channel.
2. To assign a channel start action to the buttons, in the *Channel start management* section, select a channel for each button from the list.
3. To save, click **OK**.

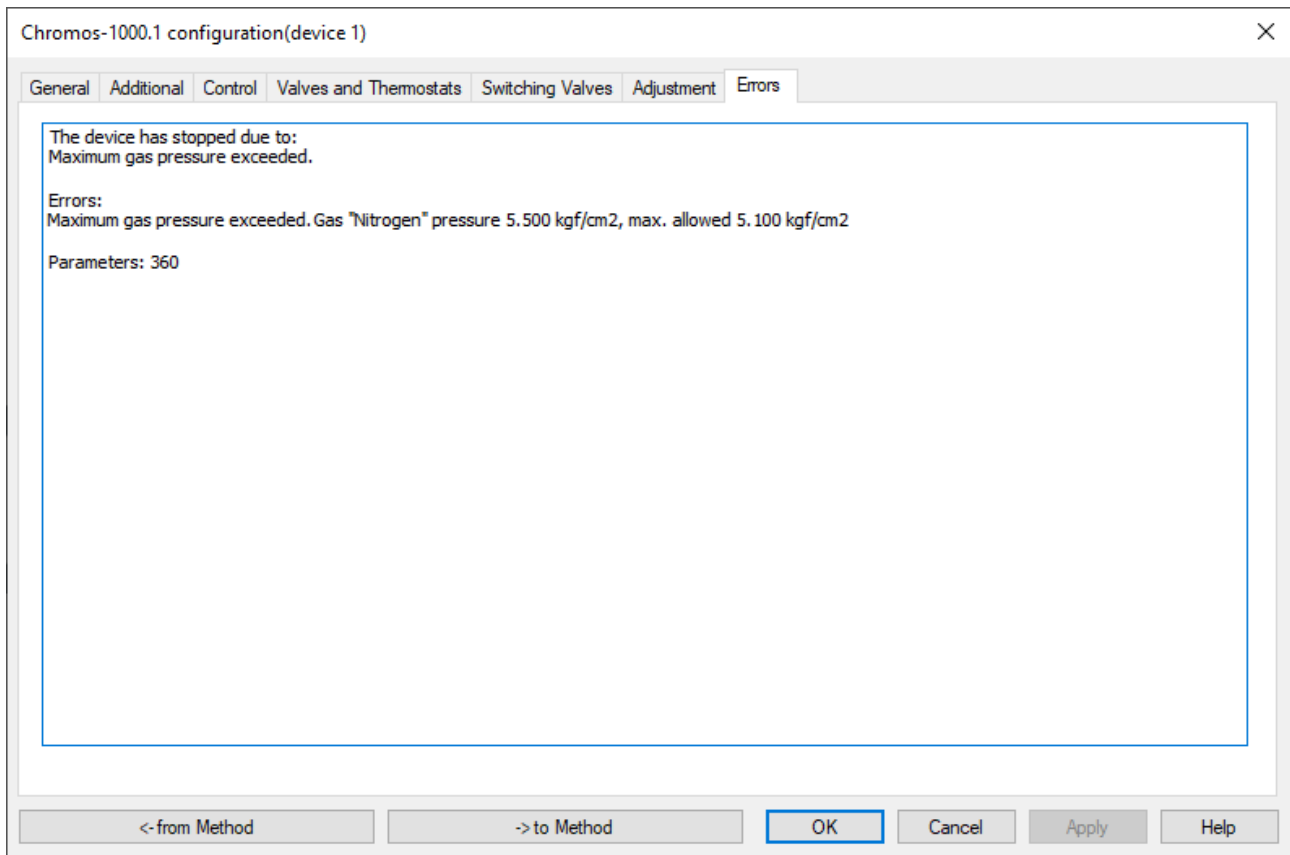

Fig. 75: Chromos GC-1000.1 Configuration > Errors

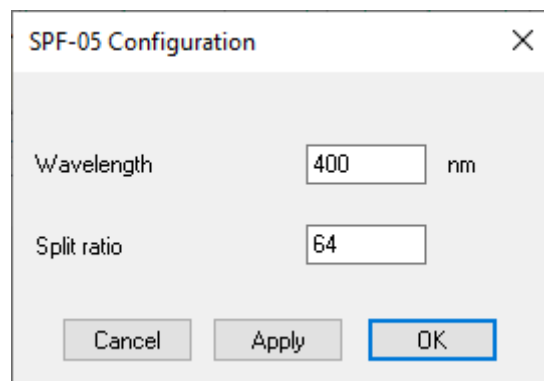

Fig. 76: SPF-05 Configuration

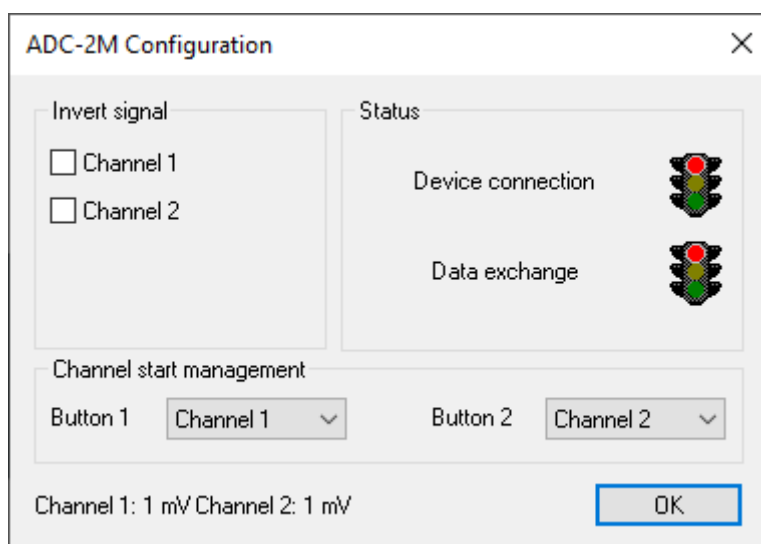

Fig. 77: ADC-2M Configuration

7.4. Chromos LAS-23

The *LAS-23 Configuration* window displays instrument controls and settings. The *General* tab contains the instrument controls, as well as sampler and error indicators. The *Settings* tab allows to select the sampler settings and displays the instrument firmware version.

Tip: See also Operation Manual “Liquid Autosampler «LAS-23»”.

To control the sampler, navigate to *LAS-23 Configuration > General* (Fig. 78) and select the desired action:

- To perform washing, click **Wash**.
- To perform adjustment, click **Adjust**.
- To replace a syringe, click **Replace Syringe**.
- To stop the instrument, click **Stop**.

To use manual wash, in the *Manual wash* section, set the manual washing parameters:

- For top down wash, check the **Top down** box and select the time from the list (0–28, in seconds).
- In the *Quantity* field, select the number of washes (0–15) from the list.
- In the *From vial* field, select the source vial from the list.
- In the *To vial* field, select the target vial from the list.
- In the text box, enter the injection volume (in μL).

To select the sampler settings, navigate to *LAS-23 Configuration > Settings* (Fig. 79) and do the following:

1. In the *Sampling loading speed* field, enter the sampling rate (1–200, in $\mu\text{L/s}$).
2. In the *Sample injection speed* field, enter the sample injection rate (1–300, in $\mu\text{L/s}$).
3. In the *Time inside the injector before dosing* field, enter the time the sample stays in the injector before its injection (0–100, in seconds).
4. In the *Time inside the injector after dosing* field, enter the time the sample stays in the injector after its injection (in seconds).
5. In the *Vial injection depth* field, enter the depth of injection into the vial (in mm).
6. In the *Injector injection depth* field, enter the depth of injection into the injector (in mm).
7. In the *Syringe injection speed* field, enter the rate of syringe injection into the injector (in

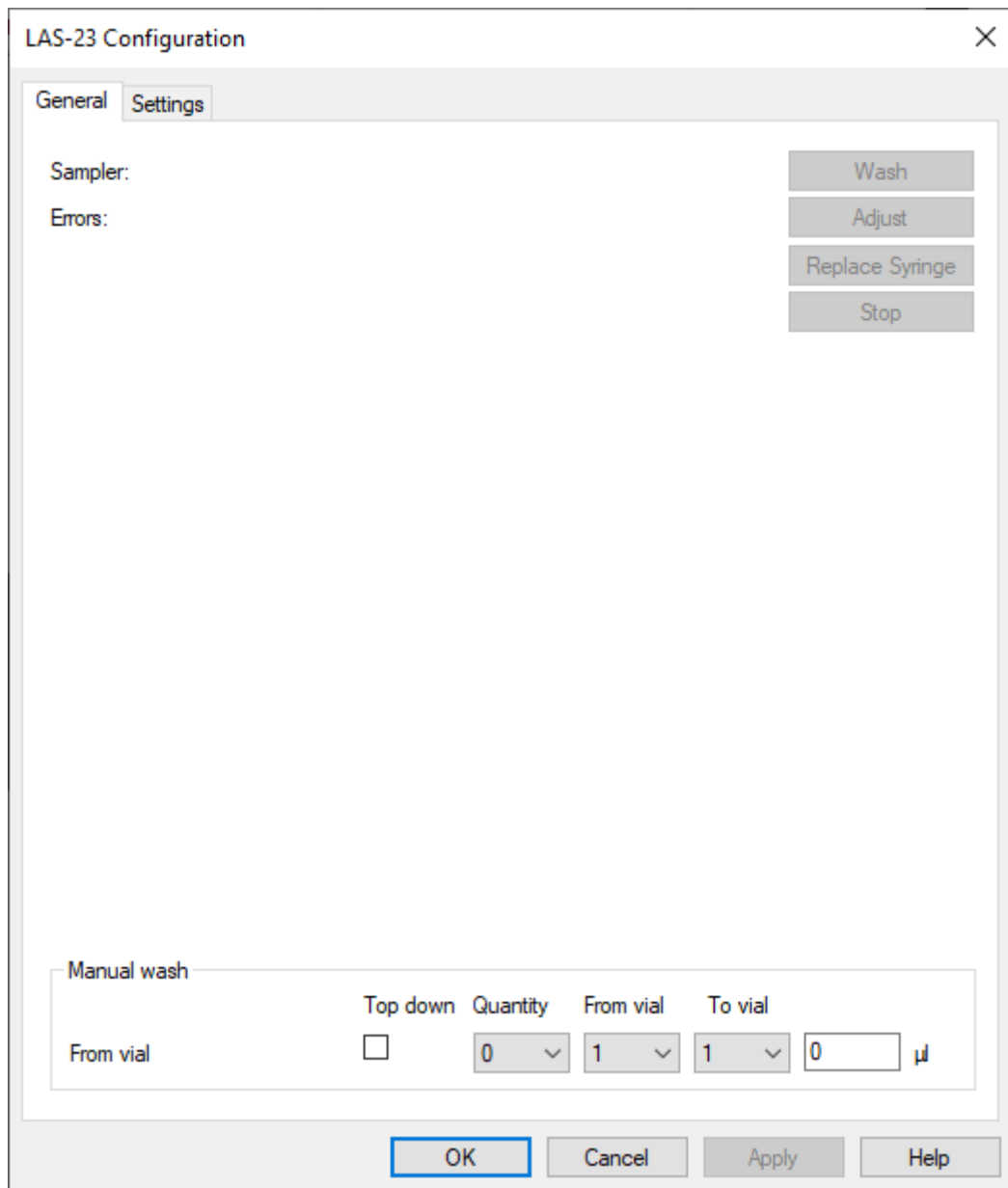

Fig. 78: LAS-23 Configuration > General

mm/s).

8. In the *Syringe lifting speed* field, enter the rate of syringe removal from the injector (in mm/s).
9. In the *Syringe* field, select the syringe model from the list:
 - AGAT MSh-1 (M-1)
 - ILS FN 5µl
 - AGAT M-5
 - ILS FN 10µl
 - AGAT MSh-10M (M-10)
 - HAMILTON #701 10µl
 - HAMILTON #7001KH 1µl
 - HAMILTON 75N 5µl
 - L-Mark 10µl
 - ILS FN 25µl
 - ILS FN 50µl
 - HAMILTON #7000.5.0.5µl
10. To save, click **OK** or **Apply**.

7.5. Chromos HSS-A

In the *HSS-A Configuration* window, you can set the operating parameters and view the instrument status. Information about the instrument operation is displayed using the following indicators:

- The *Operating Mode* indicator displays the current operating mode of the instrument.
- The *Sampler* indicator displays the instrument name or the warning about sampler disconnection.
- The *Number of injections* indicator displays the number of injections.
- The *Heating time* indicator calculates the heating time.

To select the instrument operating mode:

1. Navigate to *HSS-A Configuration > General* (Fig. 80).
2. Select the instrument operating mode:
 - Stop;
 - Operation;
 - Vial purge.
1. Select checkboxes for the vials to be used.
2. To move the vial to the bottom position for filling or emptying, press the vial number button.
3. In the *Sample* field, enter the name of the sample. The entered value is added to the chromatogram passport.
4. To save, click **OK** or **Apply**.

To set the instrument operating parameters:

1. Navigate to *HSS-A Configuration > Settings* (Fig. 81).
2. In the *Heating time* field, enter the heating time (in minutes).
3. In the *Pumping time* field, enter the pumping time (in minutes).
4. In the *Needle purging time* field, enter the needle purging time (in seconds).
5. In the *Injecting time* field, enter the injecting time (in seconds).
6. In the *Injecting from one vial* field, enter the number of injections from one vial.
7. To consistently analyze a sample from a vial, select the **Take one sample in series from the same vial** checkbox.
8. In the *Instrument* field, select an instrument (sampler) from the list.
9. In the *Injection valve* field, select an injection valve from the list.
10. In the *Launch channels* field, check boxes for relevant channels.

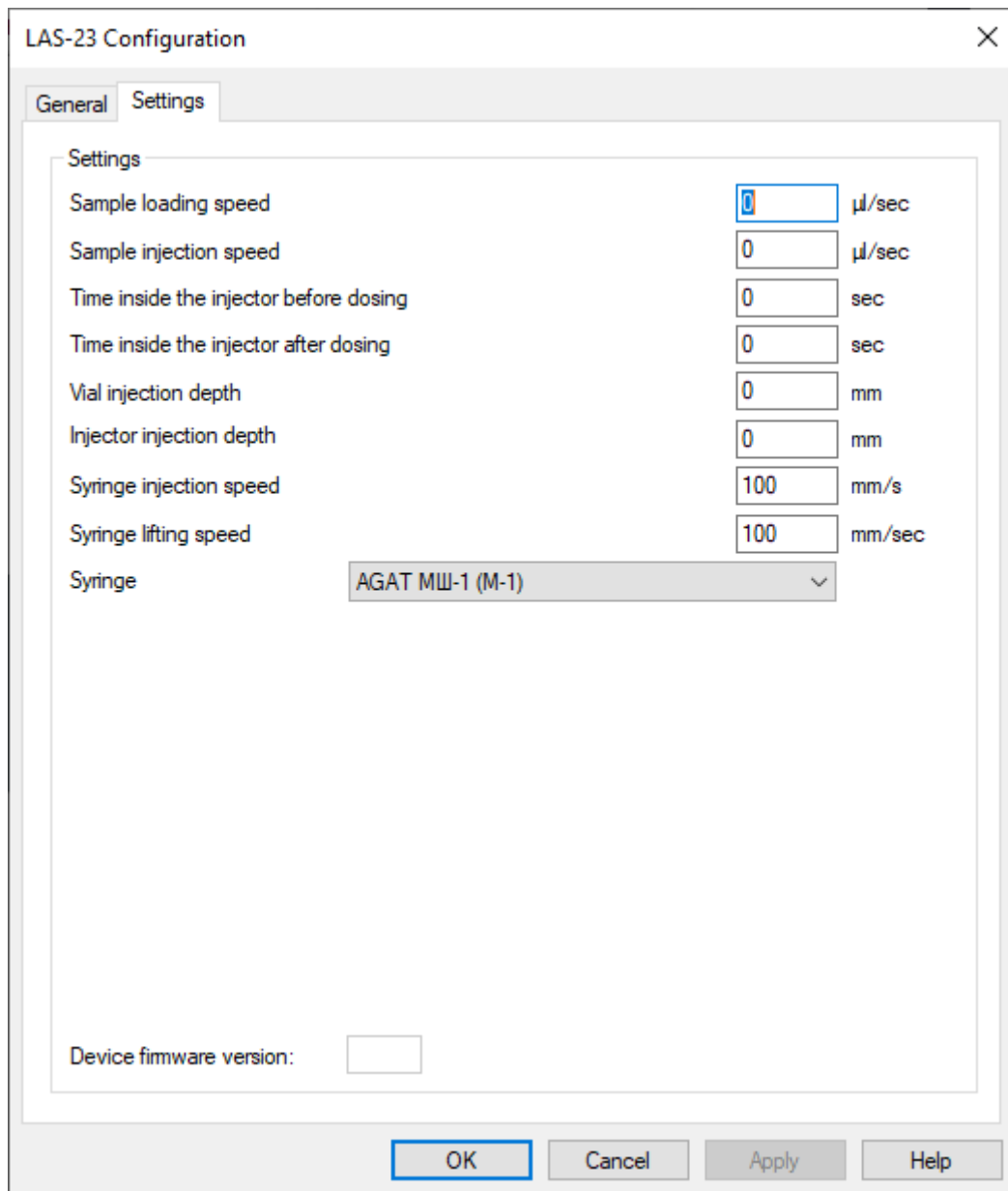

Fig. 79: LAS-23 Configuration > Settings

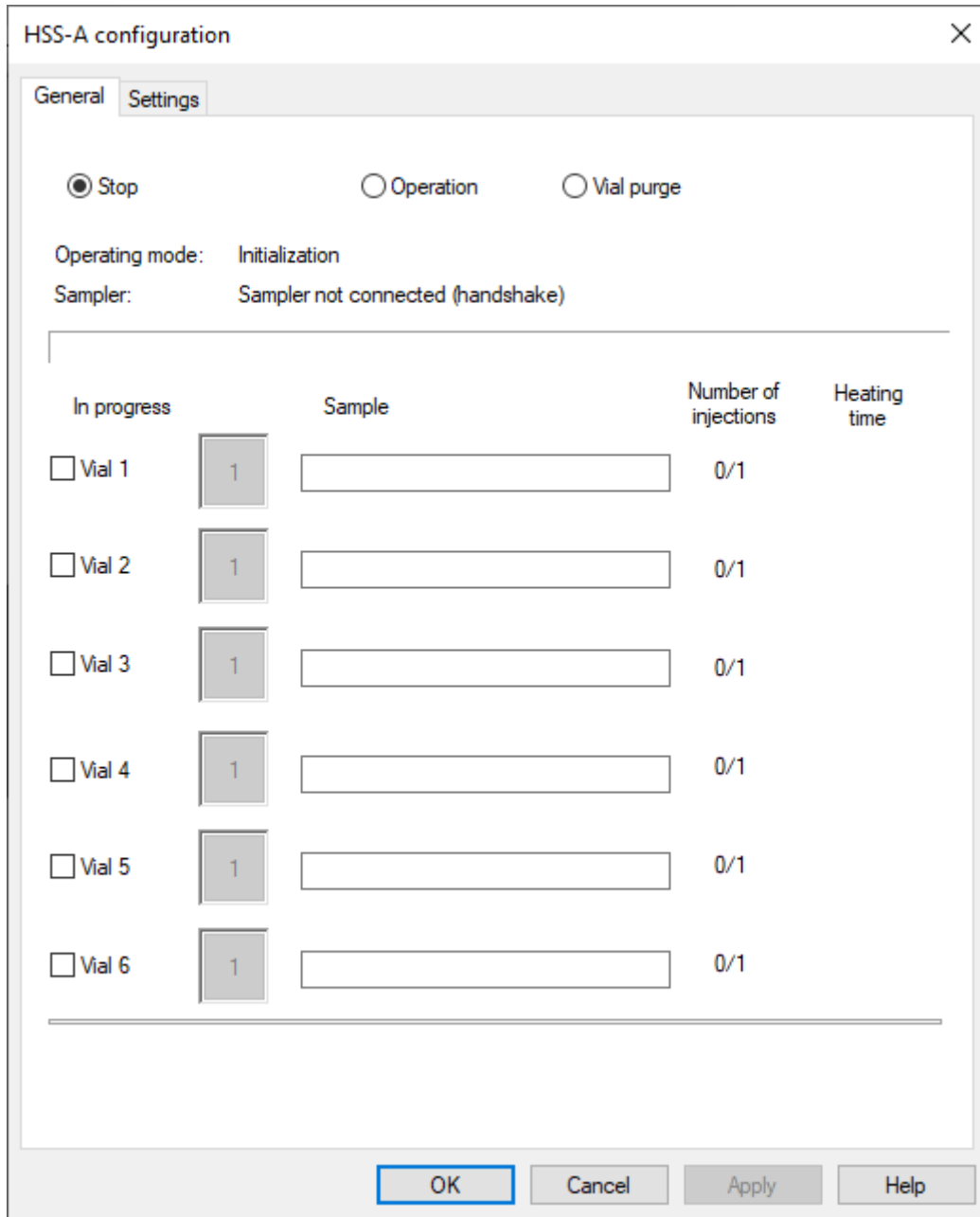

Fig. 80: HSS-A Configuration > General

11. To enable sound alerts, select the **Alert of the next vial loading time** checkbox.
12. In the *Analysis cycle time* field, enter the analysis cycle time (in minutes).
13. To save, click **OK** or **Apply**.

HSS-A configuration

General Settings

Operating mode

Heating time 20 min

Pumping time 20 min

Needle purging time 30 sec

Injecting time 15 sec

Injecting from one vial 1

Take one sample in series from the same vial

Running analyzes

Instrument Device 1 (Chromos GC-1000)

Injection valve Valve-1

Launch channels 1 2 3 4

Vial loading sound alerts

Alert of the next vial loading time

Analysis cycle time 100 min

OK Cancel Apply Help

Fig. 81: HSS-A Configuration > Settings

7.6. Chromos HSS-A2

The *HSS-A2 Configuration* window (Fig. 82) displays settings and indicators. The *Operating Mode* section displays the instrument status. In the *Settings* section, you can select the following instrument operating parameters:

1. In the *Pumping time (min)* field, enter the pumping time (in minutes).
2. In the *Holding time (min)* field, enter the holding time (in minutes).
3. In the *Loop purging time (s)* field, enter the loop purging time (in seconds).
4. In the *Inflating pressure (kg/cm²)* field, enter the inflating pressure (in kg/cm²).

5. In the *Needle airflow rate (cm³/min)* field, enter the needle airflow rate (in cm³/min).
6. In the *Carrier gas type* field, select the carrier gas type from the list:
 - Nitrogen;
 - Helium;
 - Argon;
 - Air;
 - Hydrogen.
1. In the *Instrument* field, select the connected instrument from the list.
2. In the *Method* field, click **Change**. The *Select Method* window opens.
3. In the *Select Method* window, select the method and click **OK**.
4. To move the vial to the bottom position for filling or emptying, press the relevant vial number button.
5. To save the settings and close the window, click **Close**.

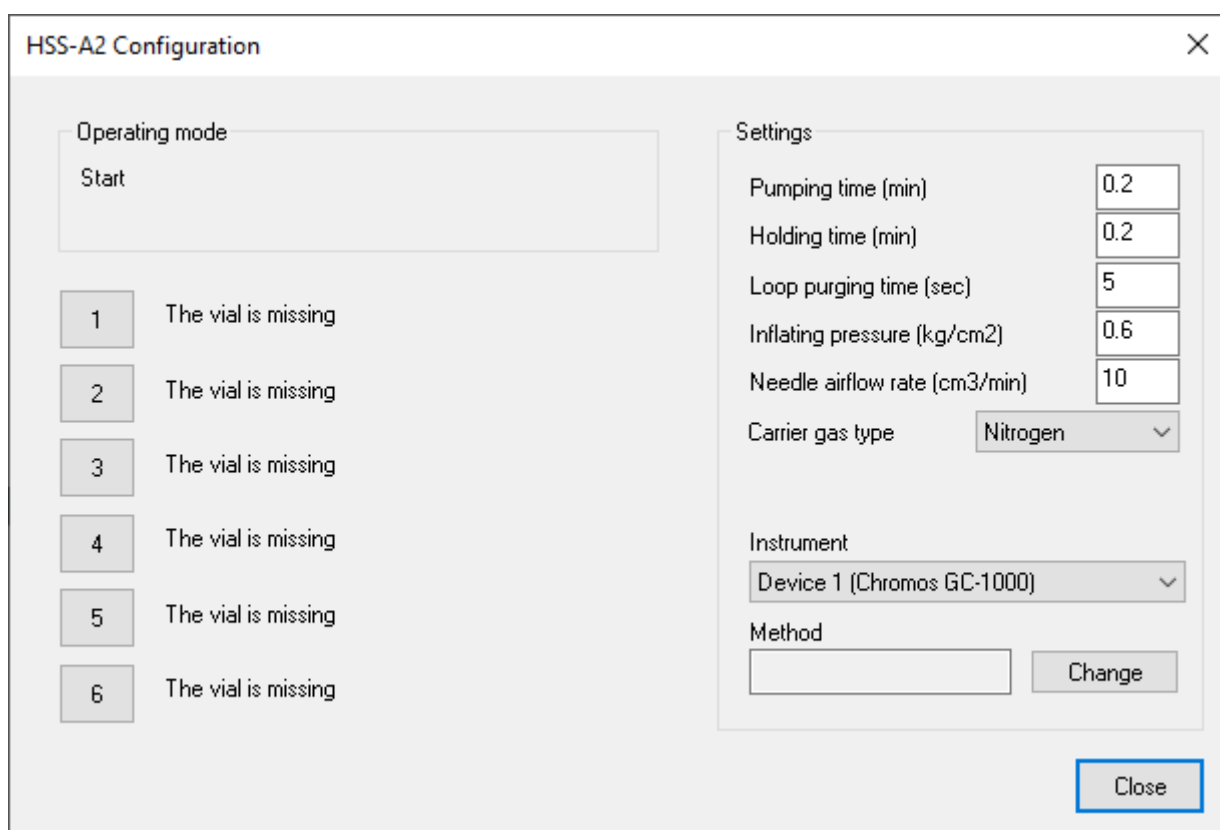



Fig. 82: HSS-A2 Configuration

You can control the instrument using a scheduler. To do this, on the control panel, click  **Scheduler**. The *HSS-A2 Scheduler* window opens (Fig. 83). In this window, you can do the following actions:

- To add a vial, click **Add**.
- To remove a vial, click **Remove**.
- To move to the previous vial, click **Up**.
- To move to the next vial, click **Down**.
- To set the vial number, multiple analyses of one sample (parallel), temperature control time (in minutes) or sample data, in the table, double-click the relevant box.
- To start an operation, double-click the **Run**.
- To abort the current operation, click **Abort current**.
- To stop all operations, click **Stop all**.

The *Operating Mode* indicator displays the current instrument status. The *Gas flow regulator* indicator displays the flow rate, measured pumping pressure at the GFR outlet (Pmeas) and voltage at the GFR valve (Vvalve). If there is no bottle, the table shows *The vial is missing*.

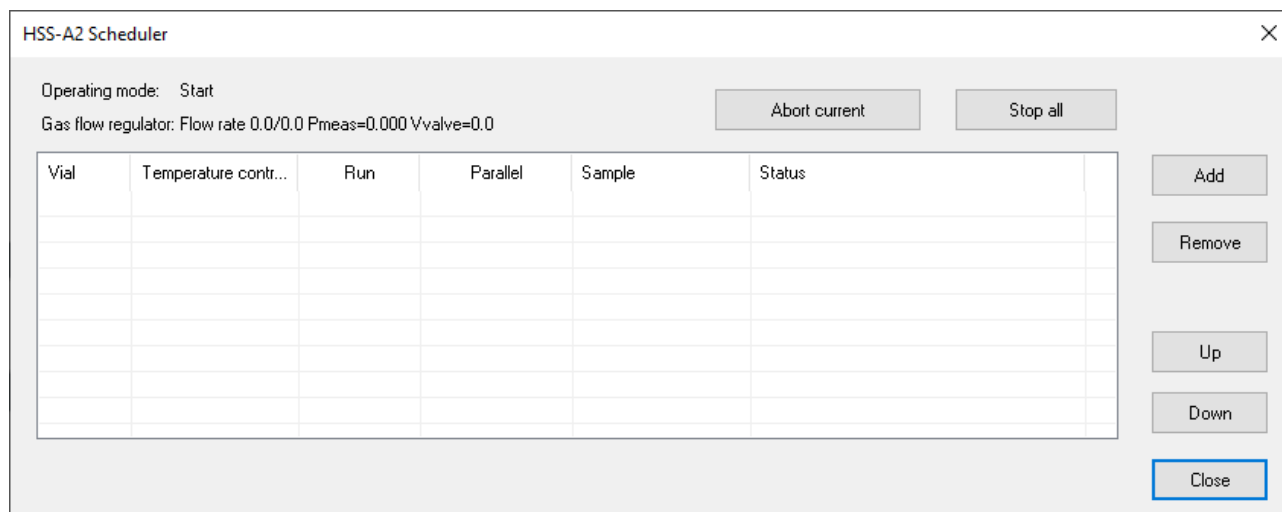

Fig. 83: HSS-A2 Scheduler

7.7. HT1500L Sampler

In the *HT1500L Configuration* window, you can set the operating parameters and view the instrument status.

The *Sampler status* indicator displays the sampler readiness for operation. The *Settings* tab also displays the instrument firmware version, serial number, and loop volume (in μL).

To create and manage an analysis, navigate to *HT1500L Configuration > General* (Fig. 84) and do the following:

1. In the *Sample name* field, enter the sample name.
2. Select either **One vial** or **Multiple vials**.
3. In the *First vial* field, enter the first vial number.
4. In the *Last vial* field, enter the last vial number.
5. In the *Number of loadings from vial* field, enter the number of loadings from the vial.
6. In the *Pre-washing* field, select the vial used for pre-washing from the list.
7. In the *Post-washing* field, select the vial used for post-washing from the list.
8. To configure analyses:
 - To add an analysis, click **Add task**.
 - To delete an analysis, click **Delete task**.
 - To delete all tasks, click **Delete all tasks**.
1. To operate the instrument:
 - To start the instrument, click **Start**.
 - To stop the instrument, click **Stop**.
 - To resume the instrument operation, click **Continue**.
 - To cancel the current analysis results, click **Reset current process**.
1. Click **OK**.

To set the sampler parameters, navigate to *HT1500L Configuration > Settings* (Fig. 85) and do the following:

- To download settings from the sampler, click **Read settings from the sampler**.

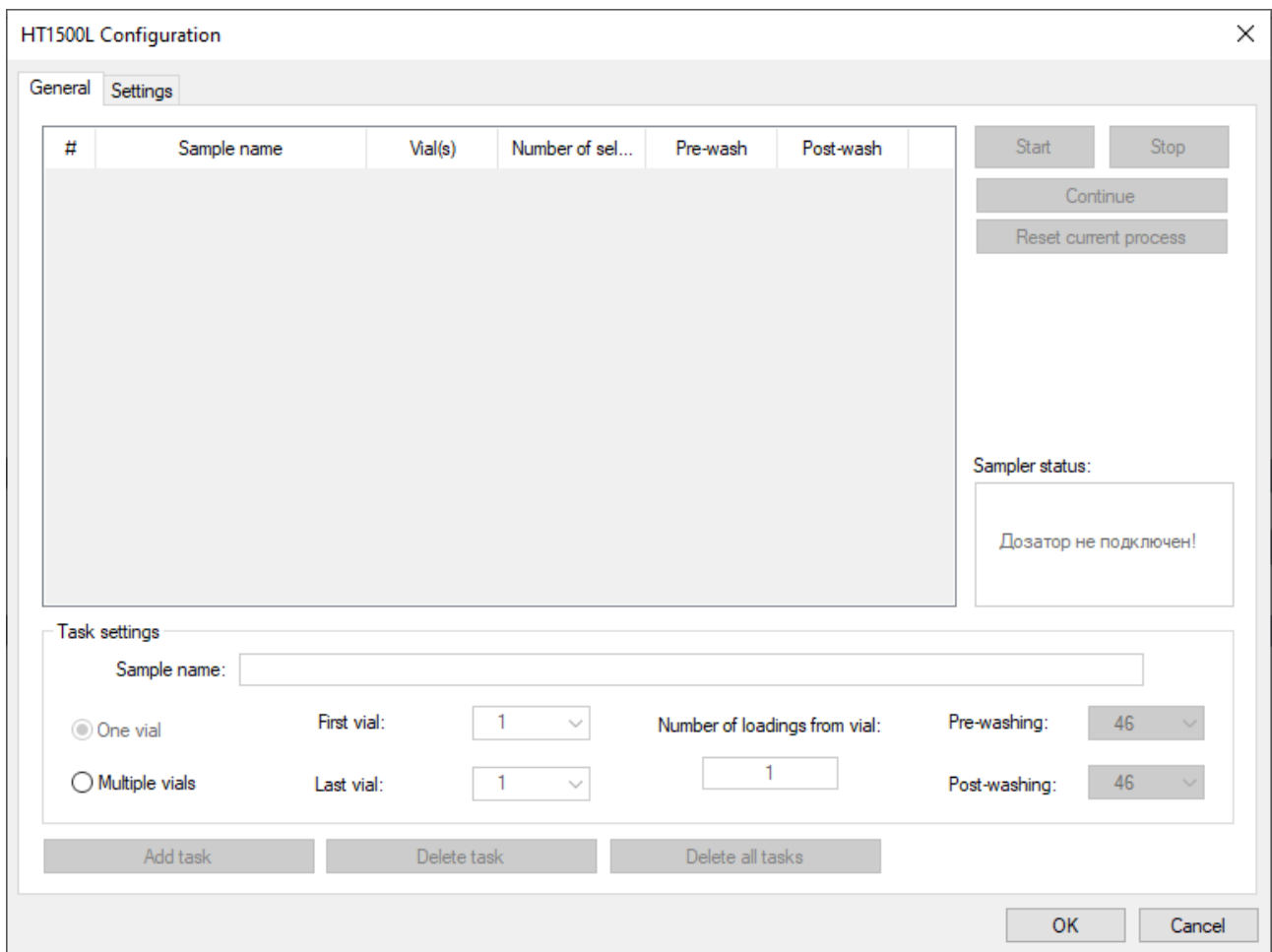

Fig. 84: HT1500L Configuration > General

- If you need to select new settings, specify the parameters and upload them to the sampler:
 1. In the *Sample (mm)* field, enter the needle insertion depth for sampling (in mm).
 2. In the *Washing (mm)* field, enter the needle insertion depth for washing (in mm).
 3. In the *Delay after needle insertion (sec)* field, enter the time delay after the needle is inserted during sampling (in seconds).
 4. In the *Sampling rate* field, select the sampling rate from the list.
 5. In the *Device* field, select a device for analysis from the list.
 6. Check boxes for the channels to be analyzed.
 7. To write settings to the sampler, click **Load settings to the sampler**.
- To download a method from the sampler, click **Read method from the sampler**.
- If you need to create a new method, specify the parameters and upload them to the sampler:
 1. To use pre-washing or post-washing, select the **On** checkbox in relevant sections.
 2. In the *Volume (μL)* field, enter the volume of substance used for washing.
 3. Select whether washing depends on injection or vial change:
 - Before Each Injection/Before Vial Change;
 - After Each Injection/After Vial Change.
 1. In the *Correction for viscosity (delay, sec)* field, enter the time delay for viscosity correction (in seconds).
 2. To write method settings to the sampler, click **Load method to the sampler**.
- To perform washing:
 1. In the *Volume (μL)* field, enter the volume of substance used for washing.
 2. In the *Vial number* field, select the vial used for washing from the list.
 3. Select an object for washing:
 - Valve washing;
 - Loop washing.
 1. To start washing, click **Start**.
 2. To stop washing, click **Stop**.
- To save the settings, click **OK**.

7.8. Chromos CD+ADC

The *CD+ADC Configuration* window (Fig. 86) displays settings and indicators. In the *Device communication status* section, the color indicators show the status of instrument connection and data exchange with the instrument: the green indicator means the instrument is ready to start analysis, and the red indicator means it is not ready.

1. In the *Offset* field, enter the baseline offset value (in mV).
2. If an oven is used, in the *Temperature* field, enter the oven temperature (in °C).

Note: If no oven is used, indicate room temperature (20 °C). Permissible error is ± 5 °C.

1. To invert a signal, select the **Invert signal** check box.
2. To save, click **OK** or **Apply**.

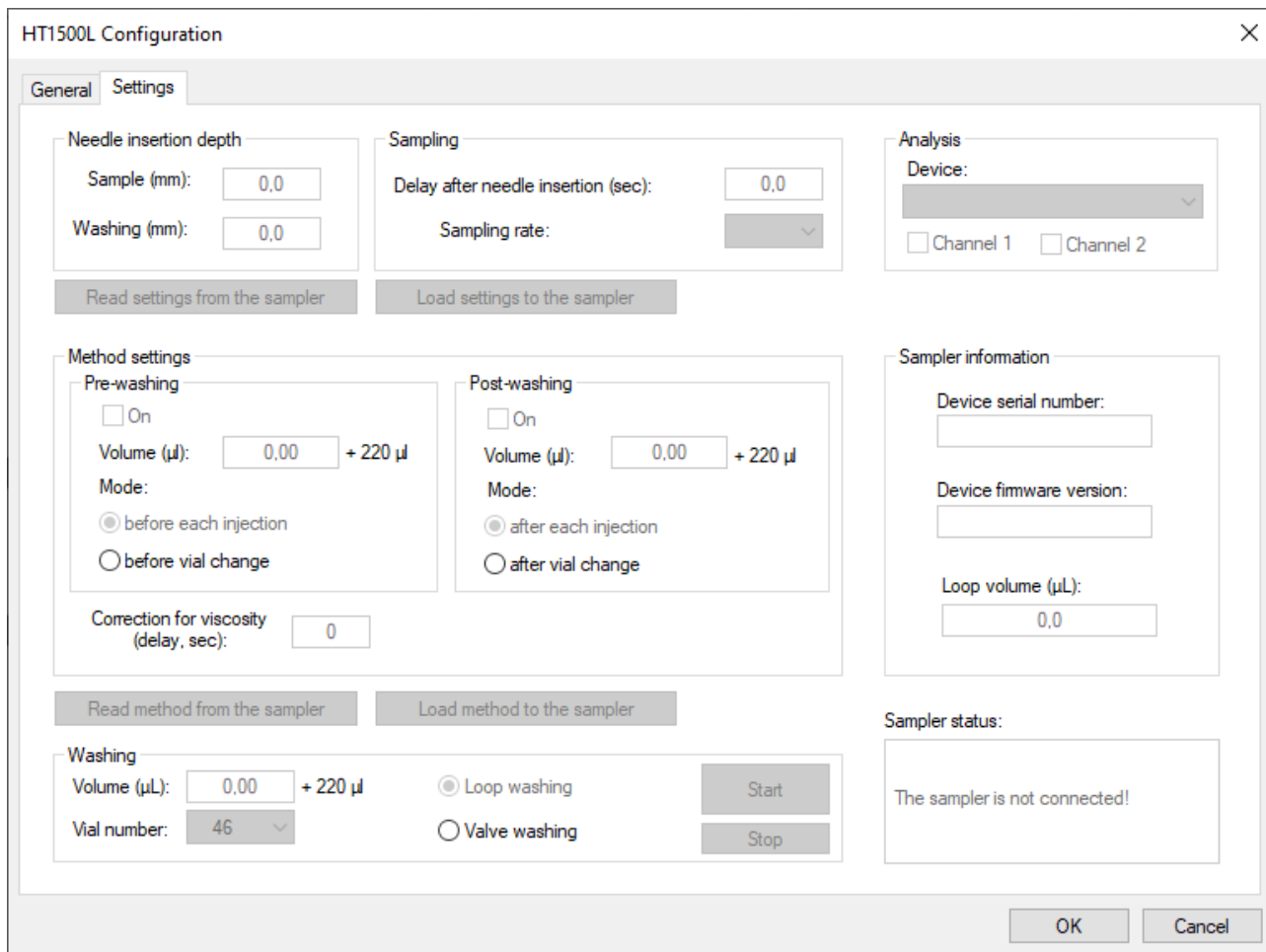

Fig. 85: HT1500L Configuration > Settings

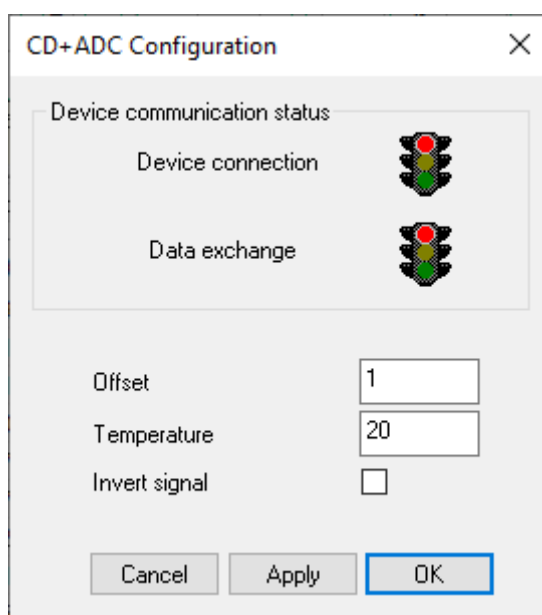

Fig. 86: CD+ADC Configuration

7.9. Chromos Cryo

In the *Cryo Configuration* window, you can set the operating parameters and view the instrument status.

For general configuration and control, navigate to *Cryo Configuration > General* (Fig. 87) and do the following:

- In the *Series* field, select a series of samples from the list.
- To maintain pressure in the cylinder, check the **Maintain pressure in the Dewar** box.
- To maintain the nitrogen level, check the **Maintain nitrogen level** box.
- To save the settings, click **OK** or **Apply**.
- To start the instrument, click **Start**.
- To stop the instrument, click **Stop**.

Instrument status information is displayed in the following fields:

- The *Sample flow rate* field displays the current sample flow rate (in cm³/min).
- The *Sample volume* field displays the current sample volume (in cm³).
- The *Mode* field displays the current instrument operating mode.
- The *Errors* field displays errors that have occurred during instrument operation.

To configure method parameters, navigate to *Cryo Configuration > Method* (Fig. 88).

- If the parameters are already written to an existing method, do the following:
 1. To retrieve the parameters from the existing method, click **<- from Method**. The *Select Method* window opens.
 2. In the *Select Method* window, select the method and click **OK**.
- If you need to set new parameters, do the following:
 1. In the *Input line purging* field, enter the input line purging time (in minutes).
 2. In the *Holding the concentrator in the cold zone position* field, enter the time the concentrator is held in the cold zone (in minutes).
 3. In the *Concentration* field, enter the sample volume to pass through the column in the cooling position (in cm³).
 4. In the *Holding the middle position* field, enter the time the middle position is held (in minutes).
 5. In the *Focus* field, enter the sample volume to pass through the column in the middle position (in cm³).
 6. In the *Desorption* field, enter the desorption time (in minutes).
 7. In the *Instrument* field, select an instrument from the list.
 8. In the *Method* field, select a method, click  **Select Method**. The *Select Method* window opens.
 9. In the *Select Method* window, select the method and click **OK**.
 10. In the *Number of measurements in series* field, enter the number of measurements in the series.
 11. To write parameters to the method, click **-> to Method**. The *Select Method* window opens.
 12. In the *Select Method* window, select the method and click **OK**.
 13. To save, click **OK** or **Apply**.

For special setup, navigate to *Cryo Configuration > Settings* and do the following:

- If the parameters are already written to an existing method, do the following:
 1. To retrieve the parameters from the existing method, click **<- from Method**. The *Select Method* window opens.
 2. In the *Select Method* window, select the method and click **OK**.
- If you need to set new parameters, do the following:
 1. To open the valve settings dialog box, click **Valves**.

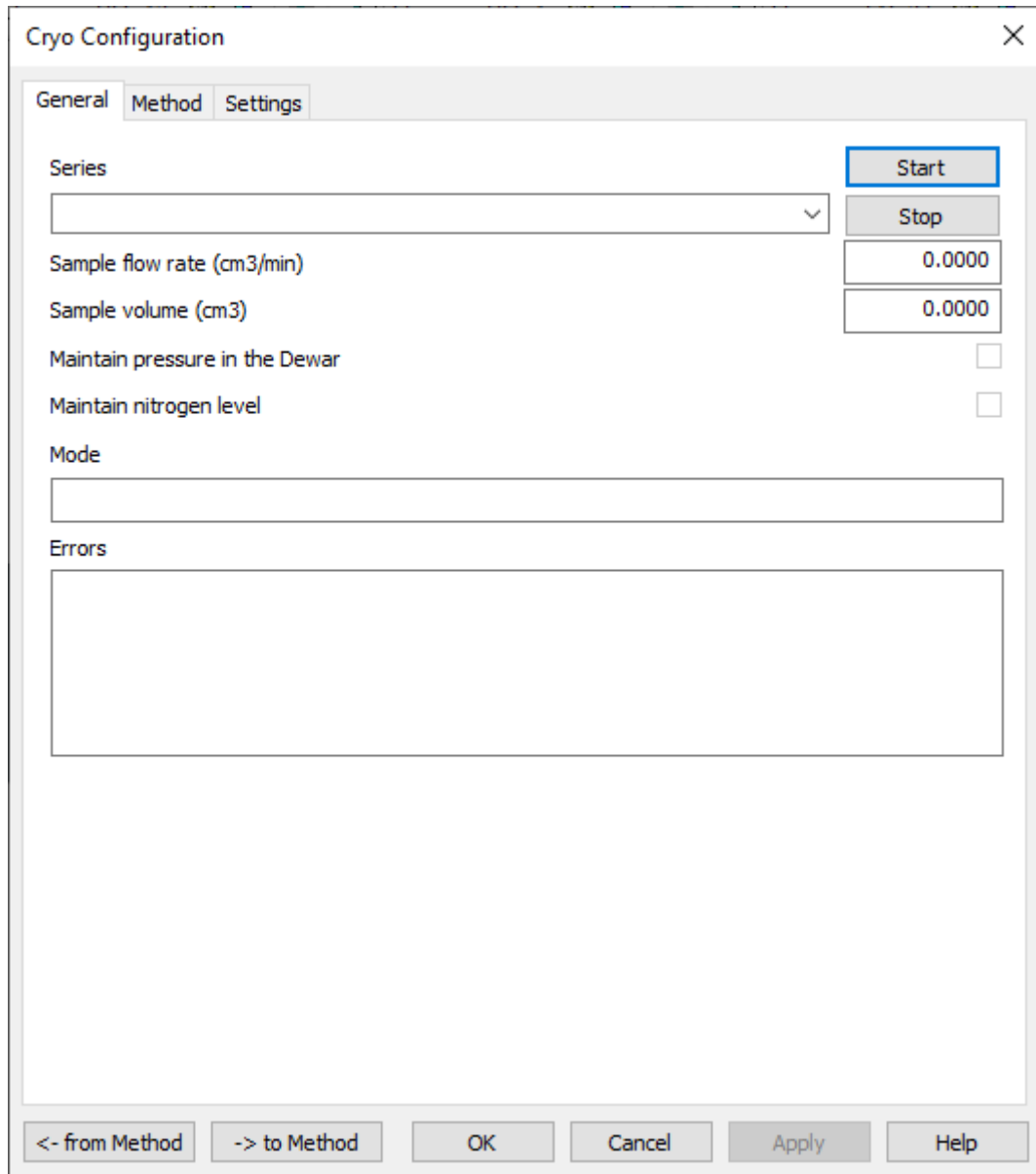

Fig. 87: Cryo Configuration > General

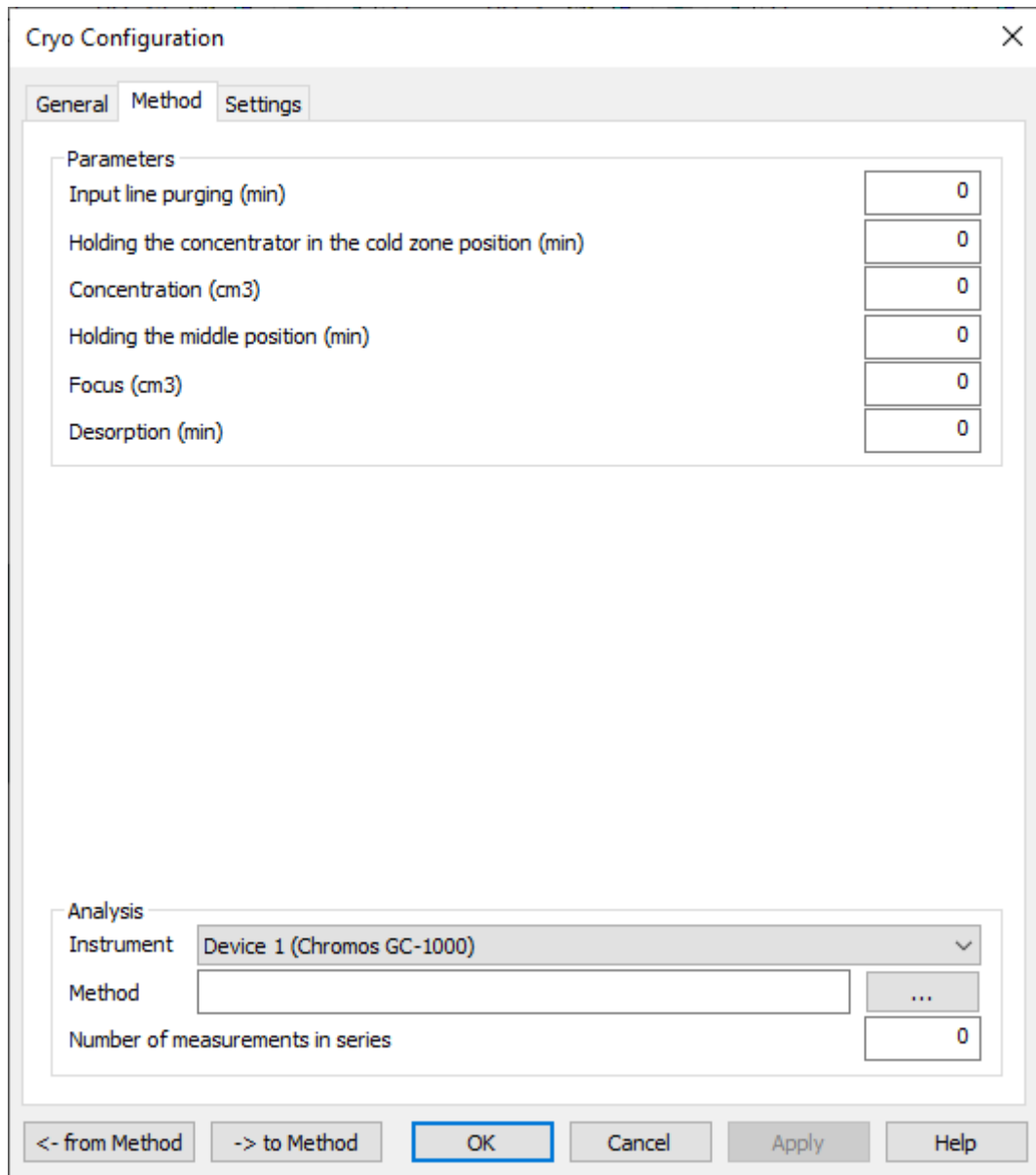

Fig. 88: Cryo Configuration > Method

2. To open the Plug&Play connection menu, click **Plug&Play**.
3. To switch the valve, click **Switch**.
4. In the *Oven temperature (°C)* section, in the *Set* field, enter the oven temperature (0–360, in °C).
5. In the *Sample flow rate (cm³/min)* section, in the *Tolerance* field, enter the tolerance value (0–360, in cm³/min).
6. In the *Sample flow rate (cm³/min)* section, in the *Set* field, enter the sample flow rate (0–360, in cm³/min).
7. In the *Middle* field, enter an angle value for column mid-positions (0–360, in degrees).
8. In the *Cooling* field, enter an angle value for the column position during cooling (0–360, in degrees).
9. In the *Heating -> Cooling* field, enter the column movement speed during transition from heating to cooling (0–360, in degrees/min).
10. In the *Cooling -> Middle* field, enter the column movement speed during transition from cooling to mid-positions (0–360, in degrees/min).
11. In the *Middle -> Heating* field, enter the column movement speed during transition from mid-positions to heating (0–360, in degrees/min).
12. In the *Additional thermostat (°C)* section, in the *Tolerance* field, enter the tolerance value (0–360, in °C).
13. In the *Additional thermostat (°C)* section, in the *Set* field, enter the oven temperature (in °C).
14. To write parameters to the method, click -> **to Method**. The *Select Method* window opens.
15. In the *Select Method* window, select the method and click **OK**.
16. To save, click **OK** or **Apply**.

Instrument status information is displayed in the following fields and indicators:

- The *Heater temperature in the Dewar (°C)* indicator displays the heater temperature in the cylinder (in °C).
- The *Nitrogen pressure in the Dewar (kg/cm²)* indicator displays the nitrogen pressure in the cylinder (in kg/cm²).
- The *Level sensor temperature (°C)* indicator displays the level sensor temperature (in °C).
- The *Current column position* indicator displays the current column position.
- The valve indicator displays the current (in mA) applied to switch the valve, as well as the color scale of its permissible range.
- The *Measured* fields display measured values for relevant parameters.

7.10. EChD+CD

In the *EChD+CD Configuration* window (Fig. 90), you can set the operating parameters and view the instrument status. The *Status* indicator displays the instrument operating status. The *Current ADC value* indicator displays the current ADC value.

Note: To avoid ambiguity, in this Manual, “EChD” stands for an electro-chemical detector, while “ECD” refers to an electron capture detector.

To set the EChD operating parameters, do the following (some fields are active only in certain operating mode):

1. In the *Detector operating mode* field, select the operating mode:
 - Direct current EChD;
 - Pulsed EChD;
 - Conductometer.

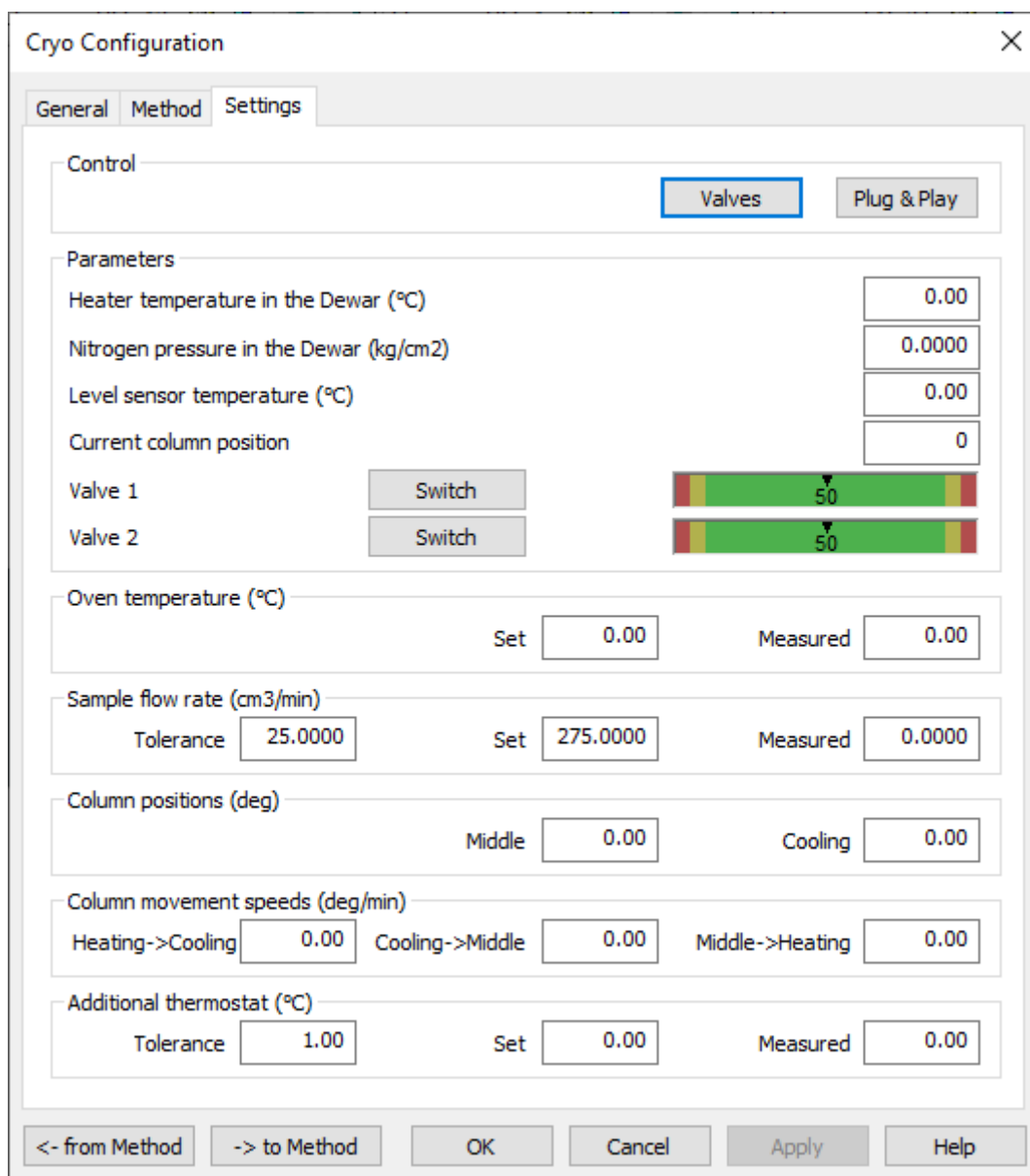

Fig. 89: Cryo Configuration > Settings

1. In the *Range* field, select the voltage range:
 - Accurate – scale of -10 to 10 V;
 - Rough – scale of -20 to 20 V.
1. In the *Detector temperature* field, enter the detector oven temperature (in °C). The adjacent field displays the measured temperature.

Note: When using a detector without an oven, indicate room temperature (20 °C). Permissible error is ± 5 °C.

1. In the *Columns temperature* field, enter the column temperature setpoint (in °C). The adjacent field displays the measured temperature.
2. In the *Working electrode voltage* field, enter the working electrode voltage value (in V).
3. In the *Clear voltage* field, enter the clear voltage value (in V).
4. In the *Recovery voltage* field, enter the recovery voltage value (in V).
5. In the *Delay time* field, enter the delay time (in seconds).
6. In the *Clear time* field, enter the cleaning time (in seconds).
7. In the *Recovery time* field, enter the recovery time (in seconds).
8. To use the detector thermostat, select the **Use detector thermostat** checkbox.
9. To use the column thermostat, select the **Use column thermostat** checkbox.
10. To invert a detector signal, select the **Invert signal** checkbox.
11. To save, click **OK** or **Apply**.
12. To retrieve the parameters from the current method, click **<- from Method**.
13. To write parameters to the current method, click **-> to Method**.

Fig. 90: EChD+CD Configuration

8. References

8.1. Abbreviations and Acronyms

- ADC – analog-to-digital converter
- AED – atomic emission detector
- CC – capillary column
- CCA – chromatography computer appliance (hardware and software)
- CCD – catalytic combustion detector
- CCl₄ – carbon tetrachloride
- CD – conductivity detector
- CG – carrier gas
- CGS – “centimeter-gram-second”, the system of units used prior to the International System of Units (SI)
- CLD – chemiluminescence detector
- CO – column oven
- CU – control unit (chromatograph module), also CCB (central control board)
- DB – database
- DID – discharge ionization detector
- ECD – electron capture detector
- EChD – electrochemical detector
- (H)ELCD – (Hall’s) electrolytic conductivity detector
- FID – flame ionization detector
- FPD – flame photometric detector
- FWHM – full width at half maximum, also referred as width at half height
- GAC – gas adsorption chromatography
- GC – gas chromatograph
- GCH – gas cylinder heater, also CHD (cylinder heating device)
- GFR – gas flow regulator
- HA – Hydrogen-air
- HID – helium ionization detector
- HPLC – high performance liquid chromatography
- HSD – halogen selective detector
- HSS – headspace sampler
- HVPS – high voltage power supply
- LAS – liquid autosampler
- LC – liquid chromatograph
- LCM – low current meter
- LFF – low-frequency filter
- LSV – liquid sampling valve
- MCM – measuring and control module
- MFM – methane flow meter
- MS – mass-selective [detector]
- PC – packed column
- PCC – Pearson correlation coefficient
- PDD – pulsed discharge detector
- PED – plasma emission detector
- PFPD – pulse flame photometric detector

- PGC – process gas chromatograph
- PID – photo-ionization detector
- RID – refractive index detector
- RSD – relative standard deviation
- RTD – resistance temperature detector, also resistance thermometer
- SCLD – sulfur chemiluminescence detector
- SLF – suppression line filter
- SLP – stationary liquid phase
- SS – solid support
- SW – software
- TCD – thermal conductivity detector
- TID – thermionic detector
- TU – Technical Specification (a production standard)

8.2. Hotkeys

The table contains hotkeys for quick access to actions when using Chromos SW:

Table 6: Hotkeys

Combination	Action
Ctrl + C	Save the peak table to the clipboard (pre-select the plot, click it)
Ctrl + Ins	Save the peak table to the clipboard (pre-select the plot, click it)
Alt + Backspace	Undo the last data change
Ctrl + O	Open a chromatogram file
Ctrl + P	Generate a chromatogram report
Ctrl + S	Save a chromatogram
Ctrl + Alt + S	Save analysis results to a database
F6	Navigate to the next window
Shift + F6	Navigate to the previous window
Ins or A	Add a peak
Delete or D	Delete a peak
Alt + Delete	Delete all peaks
Alt + Shift + Delete	Delete all unknown peaks
Esc	Cancel an action
Alt + ↑ ↓ ← →	Zoom a chromatogram
↑ ↓ ← →	Move a chromatogram
Left double click	Fill the chromatogram into the window
Shift + Scroll wheel	Move a chromatogram left and right
Scroll wheel	Move a chromatogram up and down
Ctrl + Scroll wheel	Zoom a chromatogram
Shift + Left click	Move a chromatogram
N	Rapid calculation of noise and drift for a chromatogram section
Ctrl + Z	Cancel an action to move or zoom the chromatogram

8.3. Configuring Print Parameters

In the print settings system window, you can select a printer, page and paper properties.

Note: The window contents depend on the computer, on which the software is installed. Available options are subject to change.

- To open the print settings window, in the *Chromatogram* menu, select **Print Settings...**

8.4. Chromatograph Workflow

The chromatograph operating principle consists of separating a mixture of substances into components based on their adsorption characteristics, and analyzing the concentration of these components. The substances are partitioned between mobile and stationary phases. The mobile phase (eluent) is a gas or liquid, and the stationary phase is particles of a solid body or liquid applied to the surface of inert carrier.

A gas chromatograph (GC) consists of the following elements (Fig. 91):

1. Eluent source (gas cylinder).
2. Gas flow regulator.
3. Injection device (valve + sampling loop/sampler).
4. Column + oven.
5. Detector + electronic amplifier.
6. Recording device (ADC, computer).

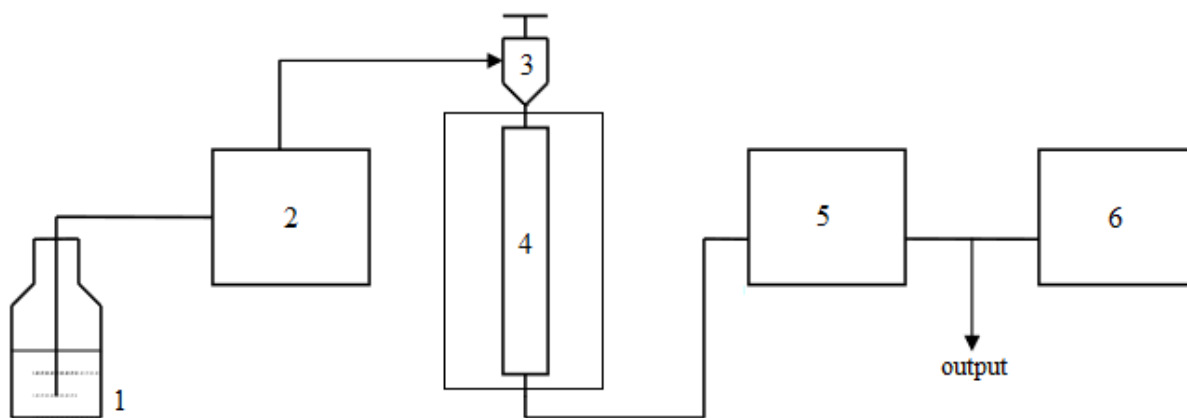

Fig. 91: Gas Chromatograph Diagram

Depending on the detector used, the chromatograph is connected to the sources of air and hydrogen (for FID), venting (to enhance FID flame), reference gas flow (for TCD), etc. A guard column can also be used to cut off unnecessary components in the GC.

A process gas chromatograph (PGC) differs from a laboratory GC by having a special purgeable or non-purgeable explosion-proof housing. The PGC uses membrane valves, in which the membrane is raised by an additional flow of air or inert gas to redirect the flow between the ports.

To operate the PGC, Chromos SW and Chromos Flow SW are used.

Note: For more details on how to operate the Chromos Flow SW, see the corresponding documentation.

A liquid chromatograph (LC) consists of the following elements (Fig. 92):

1. Eluent source (vessel with liquid).
2. Pump.
3. Sampler.
4. Column + oven.
5. Detector.
6. Recording device (ADC, computer).

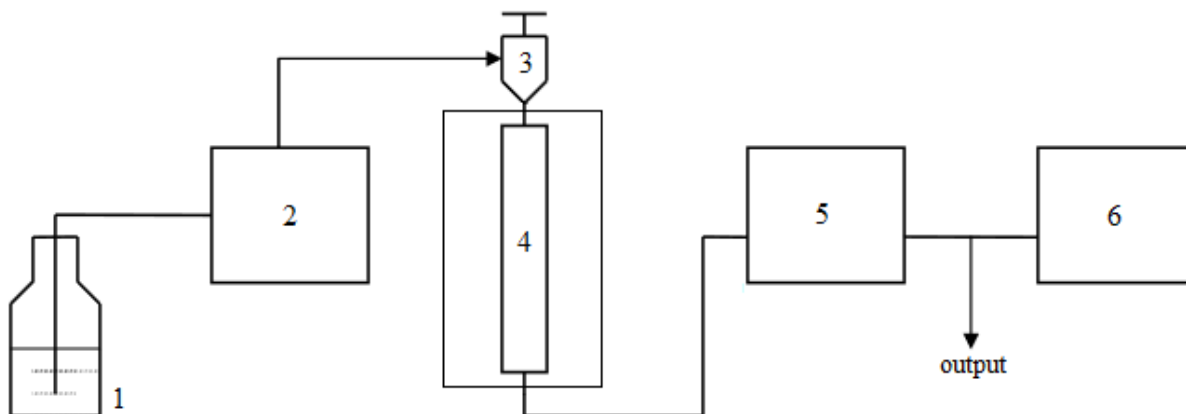

Fig. 92: Liquid Chromatograph Diagram

The LC may include the following additional devices to expand its analytical capabilities:

- Eluent preparation device (filter, degasser);
- Post-column reactor;
- Autosampler;
- Gradient device.

8.5. Additional Recording Channels

The Chromos GC-1000 Chromatograph offers additional recording channels to users with the Plug&Play privilege. They allow to record various parameters of the instrument to diagnose its condition. If necessary, these records in the form of chromatogram files can be sent to the instrument developers for diagnostics. The additional channels are configured individually for selected parameters. A parameter name is added to the chromatogram passport as a sample name. You can set the following parameters to monitor on the additional channels:

- Current temperature (ovens of columns, samplers, detectors);
- Heating power of temperature-controlled objects;
- Temperature difference (difference between the set and measured temperatures);
- Flow rate of carrier gas, hydrogen, air;
- Flow rate difference (difference between the set and measured flow rates);
- Inlet pressure of carrier gas, hydrogen, air;
- Outlet pressure of carrier gas;
- Voltage in the flow control valve of carrier gas, hydrogen, air;
- Exhaust vent position;
- Mains voltage 220 V;
- Temperature of additional zone;
- Heating power of additional zone;
- Set temperature of a programmable injector;

- Measured temperature of a programmable injector;
- Programmable injector temperature difference;
- Programmable injector heating power;
- Voltage on the cooling system pump;
- Chilling system refrigerant temperature;
- Temperature difference between temperature zones;
- Temperature difference between the temperature zone and the measured temperature in the column oven (Tc);
- Atmospheric pressure;
- Detector signal;
- Detector 300 V voltage.

To set the additional recording channels, navigate to *Configuration > Additional* (Fig. 93).

Chromos-1000.1 configuration(device 1)

General Additional Control Valves and Thermostats Switching Valves Adjustment Errors

Device structure
CU

Do not wait for the temperature program to finish

Close the oven exhaust vent

Invert Det1

Invert Det2

Invert Det3

Invert Det4

Ready state check, sec 10

Consumption
Delay before ready, sec 5
Gas flow rate, cm3 / min 10

Ignition parameters
Manual ignition

Ignition attempts 5

Flame detection level
Detector-1 0.05 mV
Detector-2 0.05 mV

Temperature zones parameters
Max. temp. Tolerance

	Max. temp.	Tolerance	
Columns	150	1	°C
Injector-1	150	1	°C
Detector-1	150	1	°C
Injector-2	150	1	°C
Detector-2	150	1	°C
Off	150	1	°C
Off	150	1	°C
Off	150	1	°C

Gas tolerance
Tolerance
Flow rate 1
Pressure 0.05

Silent mode
 Fast fan mode

Additional recording channels

5.	Gas-3 Inlet pressure	▼
6.	Voltage 220V	▼
7.	Atmospheric pressure	▼
8.	Current temperature Zone 0	▼

<- from Method -> to Method OK Cancel Apply Help

Fig. 93: Chromos-1000 Configuration > Additional

8.6. Standard Method Calculations

This section describes the implementation of standard calculations in Chromos SW. The program includes the following calculations:

- Absolute calibration (classic);
- Absolute calibration (least squares method);
- Internal standard (classic);
- Internal standard (absolute coefficients);
- Simple normalization;
- Normalization with absolute correction factors;
- Normalization with relative correction factors;
- External standard;

- Internal standard model.

Below are descriptions of each calculation:

8.6.1. Absolute Calibration (Classic)

Most detectors used in chromatography are linear. Therefore, it is possible to plot a linear relationship between the injected component concentration and the peak area (or height) in the chromatogram. The procedure for finding such a linear relationship is called a detector calibration.

To plot this calibration, several mixtures are taken in the working range of concentrations and several fillings of each mixture are performed. A calibration factor is calculated for each component in each filling. The resulting factor for each component is then averaged, and the averaged calibration factor is applied to calculate the unknown samples.

In Chromos SW, a chromatogram is added to the calibration as a level containing calibration points of all components in this chromatogram. You cannot delete one point from a component of a specific level, i.e. you can delete only the entire level (chromatogram) from the calibration. However, if any component is absent from the calibration chromatogram, during calibration a zero is set as this component quantity, and such point is excluded from the calculation of calibration factors.

Note: If it is necessary to exclude any point from calibration, you can set a zero as component quantity for this point.

Sometimes, sample volume dosed during calibration differs from that during analysis. A sample can also be diluted or concentrated. In such cases, different quantities of substance entering the detector are indicated in the *Volume* and *Dilution* fields in the chromatogram passport. If the same quantity of substance is dosed during calibration and analysis, **1** is indicated in the *Volume* field. If the sample is neither diluted nor concentrated, **1** is indicated in the *Dilution* field.

The calibration factors are calculated by formula Eq. 2:

$$K_i = \frac{C_i}{S_i} * \frac{V}{D} \quad (2)$$

In formula Eq. 2:

- K_i – calibration factor;
- C_i – known concentration of a component;
- S_i – component peak area (or height);
- V – value in the *Volume* field in the chromatogram passport;
- D – value in the *Dilution* field in the chromatogram passport.

Substance quantities during calibration are indicated in the *Quantity* fields in the *Calibration* window. It is calculated by formula Eq. 3:

$$Q_i = C_i * \frac{V}{D} \quad (3)$$

In formula Eq. 3:

- Q_i – substance quantity during calibration;
- C_i – known concentration of a component;
- V – value in the *Volume* field in the chromatogram passport;
- D – value in the *Dilution* field in the chromatogram passport.

Based on the resulting calibration factors, you can find the concentration of an unknown component using the peak area (or height). In this case, you need to fill in the *Volume* and *Dilution* fields

in the passport of the unknown sample. The calculation is made by formula Eq. 4:

$$C_i = K_i * S_i * \frac{D}{V} \quad (4)$$

In formula Eq. 4:

- C_i – component concentration to be determined;
- K_i – calibration factor;
- S_i – component peak area (or height);
- D – value in the *Dilution* field in the chromatogram passport;
- V – value in the *Volume* field in the chromatogram passport.

8.6.2. Absolute Calibration (Least Squares Method)

This method of calculation is similar to the classical absolute calibration, but instead of a linear calibration dependence, here you can use a wide range of functions. In general, the dependence of substance quantity to be determined by the chromatograph on the response in the chromatogram (peak area or height) is represented by a function (Eq. 5):

$$Q_i = F_i(S_i) \quad (5)$$

Or calculated by the following formula Eq. 6:

$$C_i = F_i(S_i) * \frac{D}{V} \quad (6)$$

In the given formula Eq. 6:

- C_i – component concentration to be determined;
- $F_i(S_i)$ – calibration function;
- D – value in the *Dilution* field in the chromatogram passport;
- V – value in the *Volume* field in the chromatogram passport.

The least squares method is applied to determine such parameters of the function that the calculated concentrations are as close as possible to the values during calibration.

$$\bar{C}_i^{cal} = F_i(S_i^{cal}) * \frac{D}{V} \quad (7)$$

$$R = \sum (\bar{C}_i^{cal} - C_i^{cal})^2; R \rightarrow \min \quad (8)$$

In the given functions Eq. 7 and Eq. 8:

- \bar{C}_i^{cal} – concentration based on the response;
- C_i^{cal} – known concentration in the calibration mixture;
- R – total standard deviation.

During calibration, optimal factors of the selected function are found. This function is used to calculate concentrations based on peak area or height.

Chromos SW offers the following types of calibration functions $F(S)$:

Table 7: **Supported Functions**

Polynomials	Reverse Polynomials	Exponential
$F(x) = k_1 * x$	$F(x) = k_1 * \frac{1}{x}$	$F(x) = e^{k_1 * x}$
$F(x) = k_1 * x + k_0$	$F(x) = k_1 * \frac{1}{x} + k_0$	$F(x) = e^{k_1 * x + k_0}$
$F(x) = k_2 * x^2 + k_1 * x$	$F(x) = k_2 * \frac{1}{x^2} + k_1 * \frac{1}{x}$	$F(x) = e^{k_2 * x^2 + k_1 * x}$
$F(x) = k_2 * x^2 + k_1 * x + k_0$	$F(x) = k_2 * \frac{1}{x^2} + k_1 * \frac{1}{x} + k_0$	$F(x) = e^{k_2 * x^2 + k_1 * x + k_0}$
$F(x) = k_3 * x^3 + k_2 * x^2 + k_1 * x$	$F(x) = k_3 * \frac{1}{x^3} + k_2 * \frac{1}{x^2} + k_1 * \frac{1}{x}$	$F(x) = e^{k_3 * x^3 + k_2 * x^2 + k_1 * x}$
$F(x) = k_3 * x^3 + k_2 * x^2 + k_1 * x + k_0$	$F(x) = k_3 * \frac{1}{x^3} + k_2 * \frac{1}{x^2} + k_1 * \frac{1}{x} + k_0$	$F(x) = e^{k_3 * x^3 + k_2 * x^2 + k_1 * x + k_0}$

8.6.3. Internal Standard (Classic)

This calculation method allows to determine absolute calibration factors during calibration (Eq. 9):

$$K_i = \frac{C_i}{S_i} \quad (9)$$

In the given formula Eq. 9:

- K_i – absolute calibration factor;
- C_i – known concentration (or mass) of a component;
- S_i – component peak area (or height).

Based on the resulting absolute calibration factors, relative calibration (correction) factors are calculated by normalizing to the absolute factor of a standard substance (Eq. 10):

$$K_i^{rel} = \frac{K_i}{K_{st}} \quad (10)$$

In the given formula Eq. 10:

- K_i – absolute calibration factor of a component;
- K_{st} – absolute calibration factor of a standard;
- K_i^{rel} – relative calibration factor of a component.

Instead of component concentrations in the calibration chromatogram, you can use masses entered in the *Concentration* field.

Calculation of the unknown sample is made by formula Eq. 11:

$$C_i = \frac{K_i^{rel} * S_i * M_{st}}{S_{st} * M_{sam}} * 100 \quad (11)$$

In the given formula Eq. 11:

- S_i – component peak area (or height);
- S_{st} – peak area (or height) of a standard;
- K_i^{rel} – relative calibration factor;
- M_{st} – value in the *Standard mass* field in the chromatogram passport;
- M_{sam} – value in the *Sample mass* field in the chromatogram passport.

Note: The sample mass is the mass of a sample taken for analysis with the standard. The standard mass is the mass of a standard added to the sample. If the concentration of the standard is known, it is entered in the *Standard mass* field, and **100** is entered in the *Sample mass* field.

8.6.4. Internal Standard (Absolute Coefficients)

An error from the discrepancy between calibration points and the plot of a standard is caused by an injection error. The amount of mixture during injection is always different. In this calculation method, plotting a calibration curve of a standard is identical to the method of absolute calibration by least squares. The least squares method is applied to determine the best calibration dependence factors $F_k(S)$.

$$C = F_k(S) \quad (12)$$

In the given formula Eq. 12:

- C – component concentration to be determined;
- $F_k(S)$ – calibration function of a component;
- S – component peak area (or height);
- k – component index.

Fig. 94 shows a calibration plot of a standard, which is based on actual points (circles) using the least squares method. The arrows correspond to the correction factor R , which shows shortage or excess of the actual quantity of the standard relative to the one calculated by the formula.

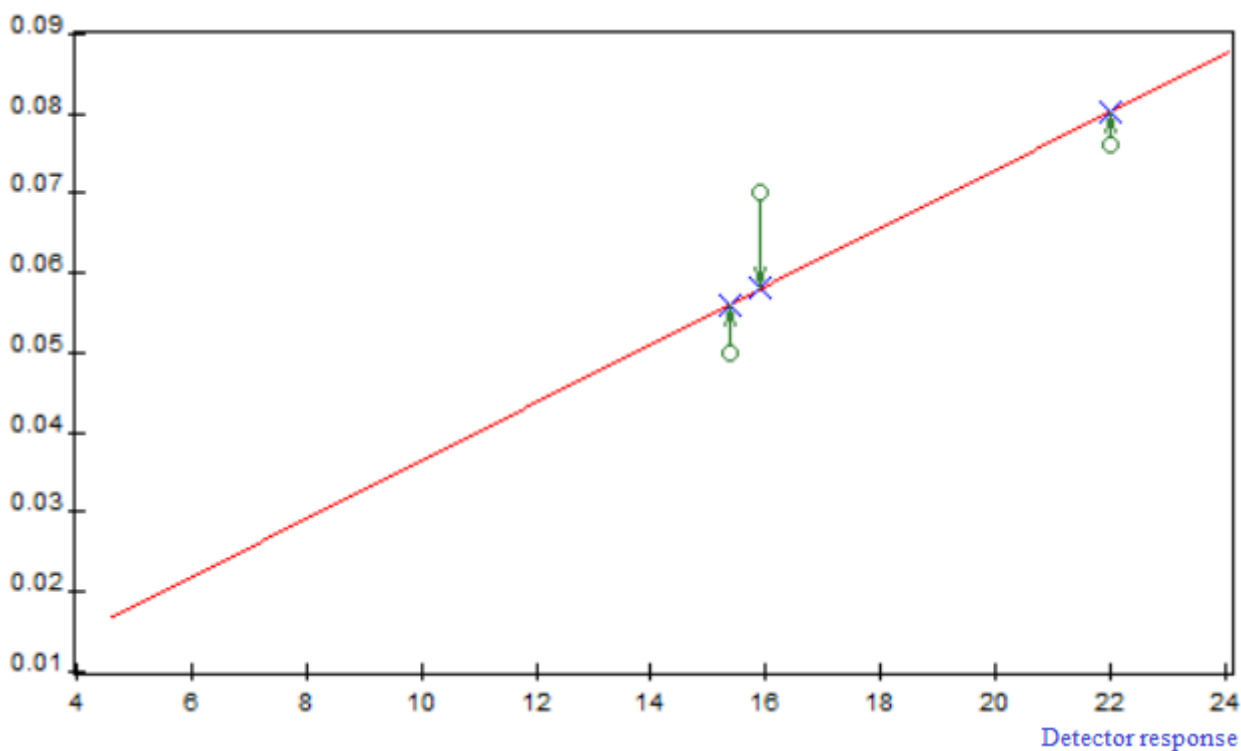

Fig. 94: Plot Based on Actual Points

All quantity-corrected points lie on the plot of the standard. The correction factor is calculated as a ratio of a corrected (cross) and actual (circle) quantity. The correction factor is calculated using the standard (Eq. 13).

$$R_i = \frac{F_{st}(S_{sti})}{C_{sti}} \quad (13)$$

In the given formula Eq. 13:

- $F_{st}(S)$ – calibration function of a standard;
- C_{sti} – concentration of a standard at the calibration point;

- i – calibration point number or calibration level.

Correction factors of the standard for each chromatogram (for each point) are calculated using the general calibration function and the actual concentration of the calibration point. One chromatogram pertains to one correction factor R_k , pointing to a sample injection error in this chromatogram. To calculate the calibration dependence of other components, the same correction factor R is used, which was calculated at the stage when the calibration of the standard was plotted. Before constructing the calibration function, component concentrations are multiplied by this factor to compensate for the injection error (Eq. 14).

$$C_i^{corr} = C_i * R_i \quad (14)$$

The corrected concentrations are used to plot the calibration graph by the least squares method. Fig. 95 shows the actual (circles) and corrected (crosses) concentrations:

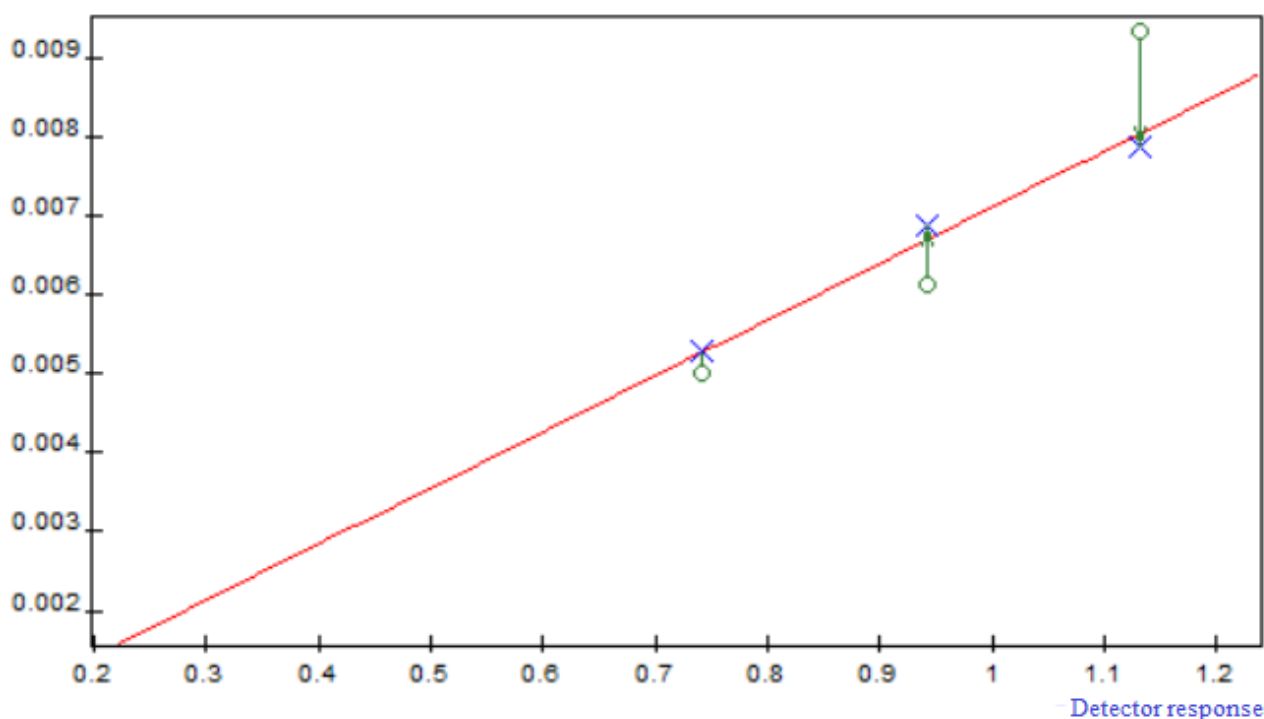

Fig. 95: Plot Based on Least Squares

Concentrations of an unknown sample are calculated by formula Eq. 15:

$$C_i = \frac{F_i(S_i)}{F_{st}(S_{st})} * \frac{M_{st}}{M_{sam}} * 100 \quad (15)$$

In the given formula Eq. 15:

- S_i – component peak area (or height);
- S_{st} – peak area (or height) of a standard;
- $F_i(S_i)$ – calibration function of a component;
- $F_{st}(S_{st})$ – calibration function of a standard;
- M_{st} – value in the *Standard mass* field in the chromatogram passport;
- M_{sam} – value in the *Sample mass* field in the chromatogram passport.

In this calculation method, the following calibration functions $F(S)$ can be used:

Table 8: Supported Functions

Polynomials	Reverse Polynomials	Exponential
$F(x) = k_1 * x$	$F(x) = k_1 * \frac{1}{x}$	$F(x) = e^{k_1 * x}$
$F(x) = k_1 * x + k_0$	$F(x) = k_1 * \frac{1}{x} + k_0$	$F(x) = e^{k_1 * x + k_0}$
$F(x) = k_2 * x^2 + k_1 * x$	$F(x) = k_2 * \frac{1}{x^2} + k_1 * \frac{1}{x}$	$F(x) = e^{k_2 * x^2 + k_1 * x}$
$F(x) = k_2 * x^2 + k_1 * x + k_0$	$F(x) = k_2 * \frac{1}{x^2} + k_1 * \frac{1}{x} + k_0$	$F(x) = e^{k_2 * x^2 + k_1 * x + k_0}$
$F(x) = k_3 * x^3 + k_2 * x^2 + k_1 * x$	$F(x) = k_3 * \frac{1}{x^3} + k_2 * \frac{1}{x^2} + k_1 * \frac{1}{x}$	$F(x) = e^{k_3 * x^3 + k_2 * x^2 + k_1 * x}$
$F(x) = k_3 * x^3 + k_2 * x^2 + k_1 * x + k_0$	$F(x) = k_3 * \frac{1}{x^3} + k_2 * \frac{1}{x^2} + k_1 * \frac{1}{x} + k_0$	$F(x) = e^{k_3 * x^3 + k_2 * x^2 + k_1 * x + k_0}$

8.6.5. Simple Normalization

This is a simple method of quantitative calculation that disregards detector sensitivity to various substances. In this calculation, the concentration of each component in the mixture is proportional to the peak height or area.

The sum of concentrations of all components is taken as 100%. If the sample has any substance that cannot be determined by the chromatographic method, but its concentration is well known, the calculation is normalized to the percentage minus this value. For example, if the concentration of water in the mixture is 2%, but the flame ionization detector fails to detect it, the calculation is normalized to 98% (to make 100% in total with water).

$$C_i = \frac{S_i}{\sum S_i} * N \tag{16}$$

In the given formula Eq. 16:

- C_i – component concentration;
- S_i – component peak area (or height);
- N – value in the *Norm* field in the chromatogram passport.

8.6.6. Normalization with Absolute Correction Factors

This method allows to calculate absolute calibration factors K_i after calibration, as in the classical method of absolute calibration. These factors are then used in normalization formulas Eq. 17 and Eq. 18:

$$K_i = \frac{C_i}{S_i} \tag{17}$$

$$C_i = \frac{S_i * K_i}{\sum S_i * K_i} * N \tag{18}$$

In the given formulas Eq. 17 and Eq. 18:

- C_i – component concentration;
- S_i – component peak area (or height);
- K_i – absolute calibration factor;
- N – value in the *Norm* field in the chromatogram passport.

The *Calibration* window displays absolute calibration factors.

8.6.7. Normalization with Relative Correction Factors

This method allows to calculate relative calibration factors K_i^{rel} as a result of calibration. These factors are then used in formula Eq. 21.

Calibration:

$$K_i = \frac{C_i}{S_i} \quad (19)$$

$$K_i^{rel} = \frac{K_i}{K_{st}} \quad (20)$$

Calculation:

$$C_i = \frac{S_i * K_i^{rel}}{\sum S_i * K_i^{rel}} * N \quad (21)$$

In the given formulas Eq. 19, Eq. 20, and Eq. 21:

- C_i – component concentration;
- S_i – component peak area (or height);
- K_{st} – absolute calibration factor of a standard;
- K_i^{rel} – relative calibration factor;
- N – value in the *Norm* field in the chromatogram passport.

The *Calibration* window displays relative calibration factors.

8.6.8. External Standard

In this method, absolute calibration is carried for one component, a standard. For other components, relative sensitivity correction factors are calculated or entered manually. The calibration factor for other components is calculated by multiplying by the relative sensitivity factor (Eq. 22, Eq. 23):

$$K_{st} = \frac{C_{st}}{S_{st}} \quad (22)$$

$$C_i = K_{st} * K_i^{rel} * S_i \quad (23)$$

In the given formulas Eq. 22 and Eq. 23:

- C_i – component concentration;
- S_i – component peak area (or height);
- K_{st} – absolute calibration factor of a standard;
- K_i^{rel} – relative calibration (correction) factor.

8.6.9. Internal Standard Model

No calibration is used in this calculation method. A reference component with a known concentration is added to the mixture. The sensitivity factor for all components in the mixture is considered equal to the sensitivity factor for the reference component.

Concentrations are calculated by formula Eq. 24:

$$C_i = \frac{S_i}{S_{mod}} * \frac{C_{mod}}{100 - C_{mod}} * 100 \quad (24)$$

In the given formula Eq. 24:

- C_i – component concentration;

- S_i – component peak area (or height);
- S_{mod} – peak area (or height) of a standard model;
- C_{mod} – concentration of a standard model.

8.7. Calculating the Split Ratio

To calculate the column outlet flow, the Poiseuille equation (Eq. 25) is used:

$$F = \frac{60 * \pi * r^4}{16 * \eta * L} * \frac{((p_i)^2) - ((p_o)^2)}{p_o} * \frac{p_o}{p_{ref}} * \frac{T_{ref}}{T} \quad (25)$$

In the given formula Eq. 25:

- r – inner column radius, cm;
- L – column length, cm;
- p_i – inlet pressure (absolute), dyne/cm²;
- p_o – outlet pressure (absolute), dyne/cm²;
- p_{ref} – reference pressure, normally equal to 1 atm;
- T – column temperature, K;
- T_{ref} – reference temperature, normally equal to – 25°C (298 K);
- η – gas viscosity at column temperature, poise;
- 60 – conversion of seconds (CGS) into minutes.

It should be noted that for this calculation, pressure is indicated in dynes/cm², and temperature is indicated in K. To convert values to these units, apply the following conversion method:

- Pressure: 1 atm = 1.01 bar = 101 kPa = 14.7 psi = 1.013e+6 dyne/cm²;
- Temperature: n K (absolute temperature) = (n+273,15)°C.

8.8. Gas Flow Regulator Operating Modes

To configure the application of gas flow regulators (GFRs) and the gas type in the *Carrier Gas Settings* window, you need to select the GFR operating mode. Chromos SW offers the following GFR operating modes:

- Constant flow rate;
- Constant pressure (outlet);
- Constant linear CC speed (outlet);
- Programmable flow rate;
- Programmable pressure (outlet);
- Programmable linear CC speed (outlet);
- At ignition, *2 plus addition;
- At ignition, *3 plus addition;
- At ignition, +20 plus addition;
- At ignition, +40 plus addition;
- At ignition, reduce by half;
- At ignition, reduce to 10;
- At ignition, turn off;
- Flowmeter;
- Economy;
- Split ratio;
- At ignition, *4.3;
- At ignition, reduce by 2.5 times;
- Constant pressure (inlet);

- Constant linear CC speed (inlet);
- Programmable pressure (inlet);
- Programmable linear CC speed (inlet).

Below are descriptions of each mode.

8.8.1. Constant Flow Rate

In this mode, a constant gas flow rate is maintained at the GFR outlet. This mode is used in the following cases: maintaining a flow rate through a packed column, discharging a capillary injector sample, a reference gas flow of a thermal conductivity detector (TCD), venting a detector, etc. To use this mode, navigate to *Configuration > General* and set the gas flow rate in cm³/min.

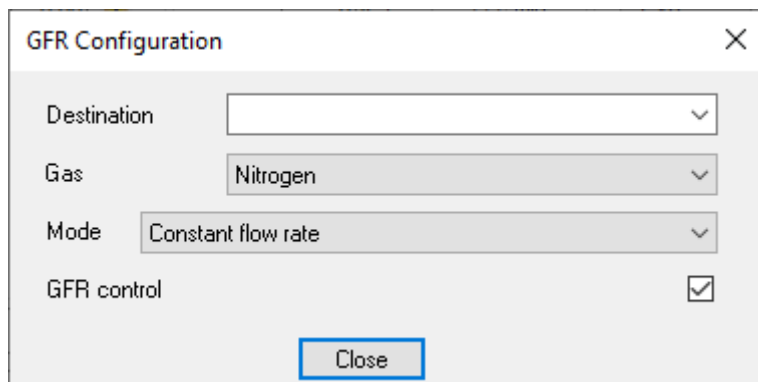

Fig. 96: Constant Flow Rate Mode

8.8.2. Constant Pressure (Outlet)

This mode is used to maintain a constant carrier gas pressure at the outlet. To use this mode, navigate to *Configuration > General* and set the carrier gas pressure in kgf/cm².

8.8.3. Constant Linear CC Speed (Outlet)

This mode is used to maintain a constant linear speed of carrier gas through a capillary column (CC) at the outlet. When selecting this mode, you need to specify the CC length and inner diameter. To use this mode, navigate to *Configuration > General* and set the carrier gas linear speed in cm/s.

8.8.4. Programmable Flow Rate

This mode is used if during analysis the gas flow rate changes according to a certain program. In this mode, you need to set the flow rate (in cm³/min) at the initial section of the program, the duration of the initial section (in min) and the flow change rate (in cm³/min/min). After entering the data for one stage of the program, you can set values for the next stage.

8.8.5. Programmable Pressure (Outlet)

This mode is used if during analysis the carrier gas pressure at the outlet changes according to a certain program. In this mode, you need to set the pressure values (in kgf/cm²) at the initial section of the program, the duration of the initial section (in min), and the pressure change rate (in kgf/cm²/min). After entering the data for one stage of the program, you can set values for the next stage.

The screenshot shows the 'GFR Configuration' dialog box with the following settings:

- Destination: [Empty dropdown]
- Gas: Nitrogen [dropdown]
- Mode: Constant linear CC speed (outlet) [dropdown]
- GFR control:
- Column length [m]: 0 [input]
- Inner diameter [mm]: 0 [input]
- Tightness control [cm³/min]: 0 [input]
- Launch the program synchronously with: Channel 2 [dropdown]
- Close button: [button]

Fig. 97: Constant Linear CC Speed (Outlet) Mode

8.8.6. Programmable Linear CC Speed (Outlet)

This mode is used if during analysis the carrier gas linear speed at the outlet changes according to a certain program. In this mode, you need to set the linear speed values (in cm/s) at the initial section of the program, the duration of the initial section (in min), and the linear speed change rate (in cm/s/min). After entering the data for one stage of the program, you can set values for the next stage. When selecting this mode, you need to specify the capillary column length (in m) and inner diameter (in mm).

The screenshot shows the 'GFR Configuration' dialog box with the following settings:

- Destination: [Empty dropdown]
- Gas: Nitrogen [dropdown]
- Mode: Programmable linear CC speed (outlet) [dropdown]
- GFR control:
- 1. 1 [input] cm/s, 2 [input] min, 0 [input] cm/s/мин, ? [input] min
- Column length [m]: 0 [input]
- Inner diameter [mm]: 0 [input]
- Tightness control [cm³/min]: 0 [input]
- Launch the program synchronously with: Channel 2 [dropdown]
- Close button: [button]

Fig. 98: Programmable Linear CC Speed (Outlet) Mode

8.8.7. At Ignition, *2 Plus Addition

This mode is used to control the hydrogen flow rate to facilitate flame ignition in a flame ionization detector (FID). To use this mode, navigate to *Configuration > General* and set the operating hydrogen flow rate in cm^3/min . When the instrument switches to FID flame ignition, the set hydrogen flow rate is doubled. After successful flame ignition, the hydrogen flow rate returns to its setpoint. If an ignition attempt fails, more attempts are made, with addition to the doubled flow rate. The addition to the gas flow rate is increased with each subsequent attempt, however no more than five attempts are made.

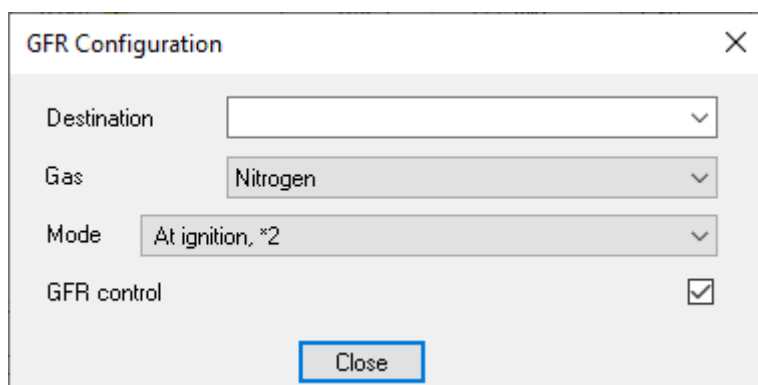

Fig. 99: At Ignition, *2 Plus Addition Mode

8.8.8. At Ignition, *3 Plus Addition

It is recommended to use this mode to ignite FTD flame. To use this mode, navigate to *Configuration > General* and set the operating gas flow rate in cm^3/min . When the instrument switches to FTD flame ignition, the set gas flow rate is tripled. After successful flame ignition, the gas flow rate returns to its setpoint. If an ignition attempt fails, more attempts are made, with addition to the tripled flow rate. The addition to the gas flow rate is increased with each subsequent attempt, however no more than five attempts are made.

8.8.9. At Ignition, +20 (+40) Plus Addition

This mode is used to facilitate the ignition of FID flame. To use this mode, navigate to *Configuration > General* and set the operating gas flow rate in cm^3/min . When the instrument switches to FID flame ignition, the set gas flow rate is increased by a fixed value ($20 \text{ cm}^3/\text{min}$ or $40 \text{ cm}^3/\text{min}$). After successful flame ignition, the gas flow rate returns to its setpoint. If an ignition attempt fails, more attempts are made, with addition to the increased flow rate. The addition to the gas flow rate is increased with each subsequent attempt, however no more than five attempts are made.

8.8.10. At Ignition, Reduce by Half

This mode can be used to control the air flow rate during FTD ignition. In this mode, at ignition the gas flow rate is halved.

8.8.11. At Ignition, Reduce to 10

This mode can be used to control the carrier gas flow rate through the column or venting to FID/FTD. In this mode, at ignition the gas flow rate is reduced to 10 cm³/min.

8.8.12. At Ignition, Turn Off

In this mode, at ignition the gas is completely cut off.

8.8.13. Flowmeter

In this mode, a GFR displays the current flow rate in the line where the GFR is installed. This mode can be used to fine tune the sample flow rate, for example, to analyze natural gas.

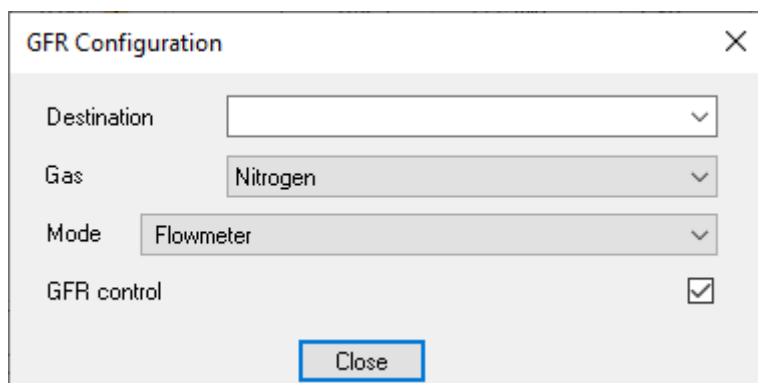

Fig. 100: Flowmeter Mode

8.8.14. Economy

In this mode, a GFR maintains the flow rate setpoint only for 10 seconds after the analysis starts. The rest of the time, the GFR maintains a flow rate of 10 cm³/min. To use this mode, navigate to *Configuration > General* and set the flow rate. When the instrument enters this mode, the GFR sets the flow rate to 10 cm³/min, and the *Ready* indicator blinks on the instrument front panel. After injecting the sample and pressing **Start/Stop**, the GFR maintains the flow rate setpoint, with the *Ready* indicator glowing constantly. After 10 seconds, the flow rate returns to 10 cm³/min.

8.8.15. Split Ratio

This mode is designed to operate a capillary column. In this mode, two GFRs (1 and 2 or 3 and 4) are involved in the operation. The odd-numbered GFR is used to set pressure at the capillary column inlet, and the even-numbered GFR is used to set the sample discharge. When the split ratio is selected, the flow rate in the discharge line is set automatically based on the flow rate through the column at the current temperature. To calculate the discharge flow rate, use column parameters given in the previous GFR (see also [Sec. 8.7. Calculating the Split Ratio](#)).

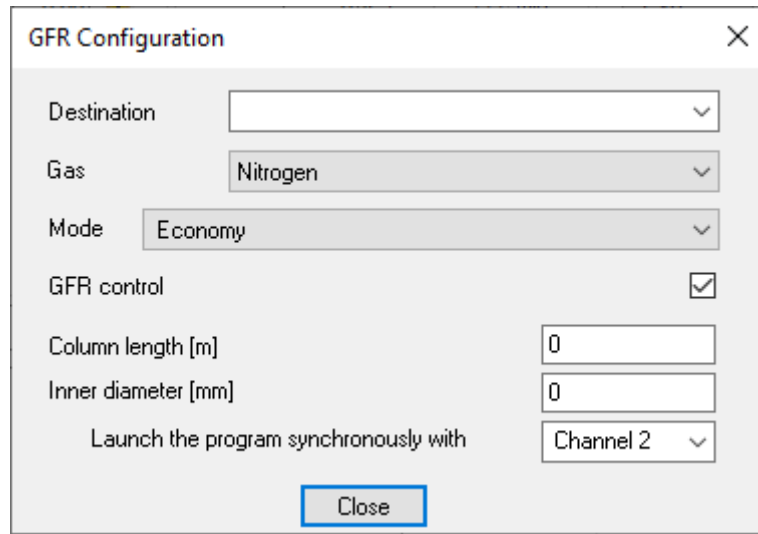

Fig. 101: Economy Mode

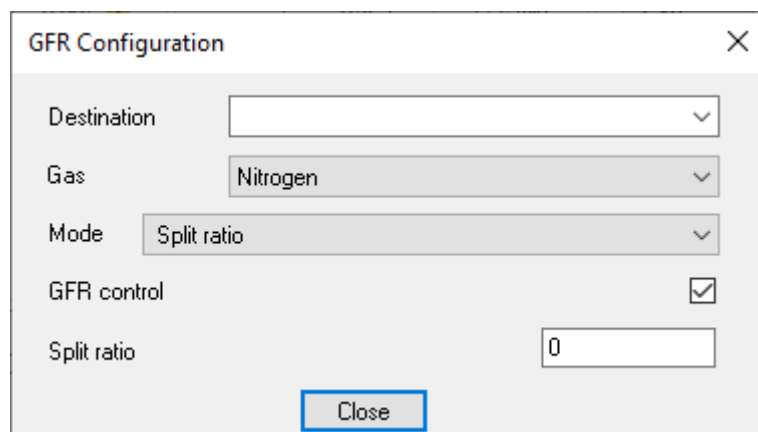

Fig. 102: Split Ratio Mode

8.8.16. At Ignition, *4.3

This mode is used to facilitate the ignition of TID flame. To use this mode, navigate to *Configuration > General* and set the operating gas flow rate in cm^3/min . When the instrument switches to FTD flame ignition, the set gas flow rate is increased by 4.3 times. After successful flame ignition, the gas flow rate returns to its setpoint.

8.8.17. At Ignition, Reduce by 2.5 Times

This mode can be used to control the air flow rate during FTD ignition. In this mode, the gas flow rate during ignition is reduced by 2.5 times.

8.8.18. Constant Pressure (Inlet)

This mode is used to maintain a constant carrier gas pressure at the inlet. To use this mode, navigate to *Configuration > General* and set the carrier gas pressure in kgf/cm^2 .

8.8.19. Constant Linear CC Speed (Inlet)

This mode is used to maintain a constant linear speed of carrier gas through a capillary column (CC) at the inlet. When selecting this mode, you need to specify the CC length and inner diameter. To use this mode, navigate to *Configuration > General* and set the carrier gas linear speed in cm/s .

8.8.20. Programmable Pressure (Inlet)

This mode is used if during analysis the carrier gas pressure at the inlet changes according to a certain program. In this mode, you need to set the pressure values (in kgf/cm^2) at the initial section of the program, the duration of the initial section (in min), and the pressure change rate (in $\text{kgf}/\text{cm}^2/\text{min}$). After entering the data for one stage of the program, you can set values for the next stage.

8.8.21. Programmable Linear CC Speed (Inlet)

This mode is used if during analysis the carrier gas linear speed at the inlet changes according to a certain program. In this mode, you need to set the linear speed values (in cm/s) at the initial section of the program, the duration of the initial section (in min), and the linear speed change rate (in $\text{cm}/\text{s}/\text{min}$). After entering the data for one stage of the program, you can set values for the next stage. When selecting this mode, you need to specify the capillary column length (in m) and inner diameter (in mm).

8.8.22. Flame Detection Level

For flame detectors, it is necessary to set a flame detection level, at which the chromatogram will be recorded. To do this, the level is measured in mV (millivolt) with no flame and with the maximum flame. Their average value is called a flame detection level, which is set in *Configuration > Additional*.

Thus, if the flame detection level is lower than the setpoint, more air-hydrogen mixture is supplied for ignition. If an ignition attempt fails, more attempts are made. The number of attempts is also set in *Configuration > Additional*.

8.9. Temperature Zones

When configuring the «Chromos GC-1000» device, you need to set the temperature zone parameters. In Chromos SW, the following temperature zones are present.

Note: For abbreviations, see [Sec. 8.1. Abbreviations and Acronyms](#).

- Injector
- FID
- TCD
- ECD
- FPD
- PID
- FTD
- CCD
- HID
- PDD
- Detector
- Valve
- Methanizer
- Desorber
- Double TC
- Heated pipeline
- Activator
- Transition
- Switch
- HSS
- HSS vials
- HSS valve
- HSS needle
- DID
- Off
- Unknown

For a new added temperature zone, the *Unknown* value is matched.

9. Troubleshooting

9.1. Restarting the Device in Case of Error

If the gas inlet pressure at the GFR is exceeded, Chromos SW displays an error message. To continue, you need to review the error report and restart the device.

1. On the control panel next to the device name, click  **Configuration**. The *Configuration* window opens.
2. In the *Configuration* window, navigate to the *Errors* tab (Fig. 103). The report shows at which GFR the pressure was exceeded.

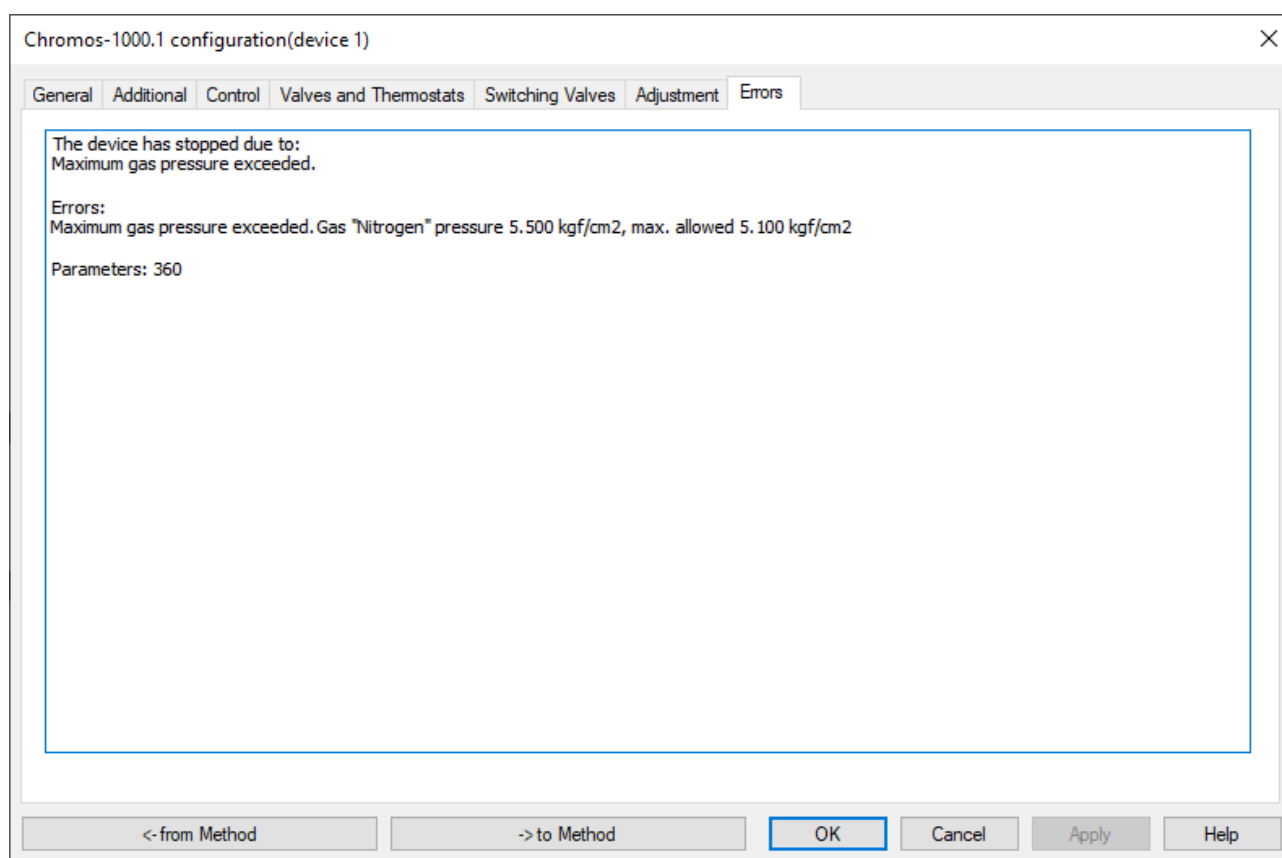





Fig. 103: Chromos-1000 Configuration > Errors

1. Click **OK**.
2. To disconnect the device, on the control panel, click  **Disconnect**.
3. Switch off the device.
4. Reduce the gas pressure, which caused the alarm (for example, by using a gearbox for the carrier gas cylinder).
5. Switch on the device.
6. To connect the device, on the control panel, click  **Connect**.

9.2. Device Connection Error

If the COM-port is selected correctly when the device is connected, the analysis recording flags  are red.

If the device fails to connect, do the following:

1. Connect the device to the computer.
2. In the *Start* menu, select **Run**, or press Win + R. The *Run* window opens.
3. In the text field, enter **devmgmt.msc** and press Enter. The *Device Manager* window opens.
4. In the *Ports (COM & LPT)* section, identify the port to which the device is connected.
5. In Chromos SW, in the *Devices* menu, select *Connection...*. The *Device Connection* window opens (Fig. 104):

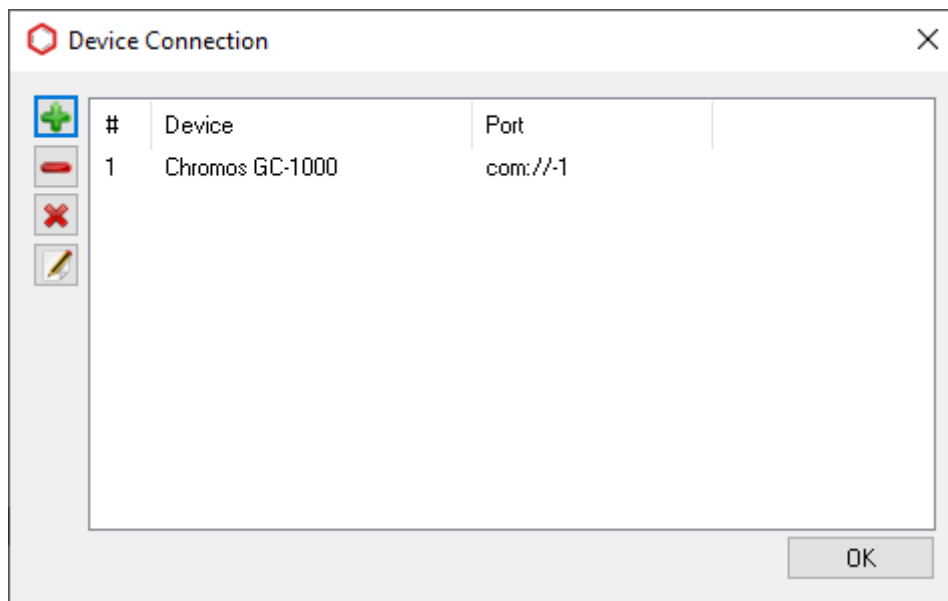

Fig. 104: Device Connection

1. To add a device, click  **Add**. The *Add New Device* window opens (Fig. 105):

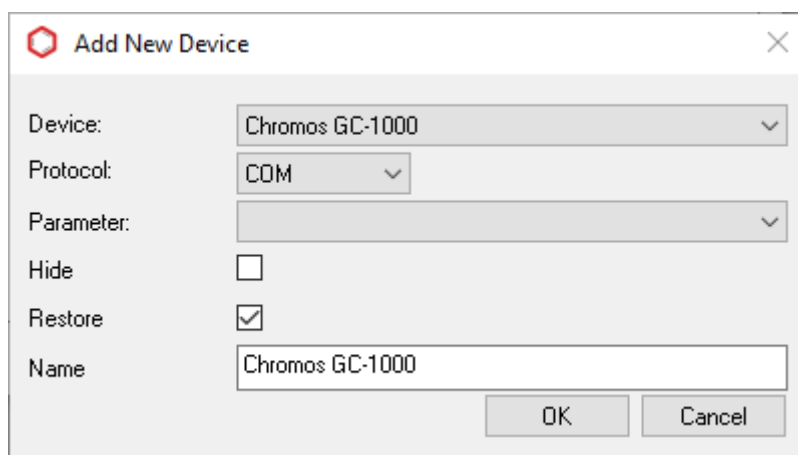

Fig. 105: Adding a Device

1. In the *Parameter* field, select the COM-port indicated in the *Device Manager*.

2. Click **OK**.

If the device fails to connect again, contact the software developer.

9.3. Debugging Using the Operation Log

The operation log allows to perform the following actions:

- To view the program progress:
- To open the log, in the *Help* menu, select **Log > View**.
- To save the program operation records:
 1. To save the log, in the *Help* menu, select **Log > Save**.
 2. Specify the directory and click **OK**.
- To send the log to the developer:
 1. To send the log to the developer, in the *Help* menu, select **Log > Send via Web**. The *Contact Technical Support* window opens.
 2. Enter your contact phone number or e-mail address to contact you and a description of your problem.
 3. Click **OK**.

10. Program Identification

10.1. Receiving the Program ID

Chromos SW has a metrologically significant part in the form of a separate calculation module. Module information (name, version, checksum) is displayed in the *About...* window. The checksum calculated using the CRC32 algorithm is a unique identifier of the calculation module.

To get the ID of your Chromos SW, in the *Help* menu select **About...** (Fig. 106).



Fig. 106: “About...”

10.2. Calculation Module Control

Chromos SW protects the calculation module from any inadvertent change. The protection is based on calculating the checksum of the file *CalcModule.dll*.

If the checksum of the calculation module changes, Chromos SW displays a warning about damage done to this file (Fig. 107) and stops running.

To check for any inadvertent change of the calculation module, you need to modify the calculation module file *CalcModule.dll* in any editor.

The module file is located in the Windows system folder:

- For 32-bit systems — C:\Windows\System32\CalcModule.dll
- For 64-bit systems — C:\Windows\SysWOW64\CalcModule.dll

After the file is modified, the Chromos software will warn that further work is impossible.

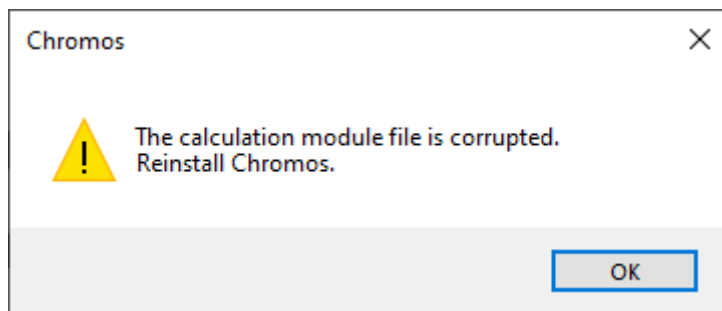

Fig. 107: Calculation Module Damage Warning